

SAP NetWeaver 7.31



SAP NetWeaver
Process Integration
Simple Use Cases for
Communication
between Advanced
Adapter Engine
Extended (AEX) & PI
Dual Stack

Document Version 1.0 – July 2012

**SAP AG**

Dietmar-Hopp-Allee 16
69190 Walldorf
Germany
T +49/18 05/34 34 24
F +49/18 05/34 34 20
www.sap.com

© Copyright 2012 SAP AG. All rights reserved.

No part of this publication may be reproduced or transmitted in any form or for any purpose without the express permission of SAP AG. The information contained herein may be changed without prior notice.

Some software products marketed by SAP AG and its distributors contain proprietary software components of other software vendors.

Microsoft, Windows, Outlook, and PowerPoint are registered trademarks of Microsoft Corporation.

IBM, DB2, DB2 Universal Database, OS/2, Parallel Sysplex, MVS/ESA, AIX, S/390, AS/400, OS/390, OS/400, iSeries, pSeries, xSeries, zSeries, z/OS, AFP, Intelligent Miner, WebSphere, Netfinity, Tivoli, Informix, i5/OS, POWER, POWER5, OpenPower and PowerPC are trademarks or registered trademarks of IBM Corporation.

Adobe, the Adobe logo, Acrobat, PostScript, and Reader are either trademarks or registered trademarks of Adobe Systems Incorporated in the United States and/or other countries.

Oracle is a registered trademark of Oracle Corporation.

UNIX, X/Open, OSF/1, and Motif are registered trademarks of the Open Group.

Citrix, ICA, Program Neighborhood, MetaFrame, WinFrame, VideoFrame, and MultiWin are trademarks or registered trademarks of Citrix Systems, Inc.

HTML, XML, XHTML and W3C are trademarks or registered trademarks of W3C®, World Wide Web Consortium, Massachusetts Institute of Technology.

Java is a registered trademark of Sun Microsystems, Inc.

JavaScript is a registered trademark of Sun Microsystems, Inc., used under license for technology invented and implemented by Netscape.

MaxDB is a trademark of MySQL AB, Sweden.

SAP, R/3, mySAP, mySAP.com, xApps, xApp, SAP NetWeaver, and other SAP products and services mentioned herein as well as their respective logos are trademarks or registered trademarks of SAP AG in Germany and in several other countries all over the world. All other product and service names mentioned are the trademarks of their respective companies. Data contained in this document serves informational purposes only. National product specifications may vary.

These materials are subject to change without notice. These materials are provided by SAP AG and its affiliated companies ("SAP Group") for informational purposes only, without representation or warranty of any kind, and SAP Group shall not be liable for errors or omissions with respect to the materials. The only warranties for SAP Group products and services are those that are set forth in the express warranty statements accompanying such products and services, if any. Nothing herein should be construed as constituting an additional warranty.

Disclaimer

Some components of this product are based on Java™. Any code change in these components may cause unpredictable and severe malfunctions and is therefore expressly prohibited, as is any decompilation of these components.

Any Java™ Source Code delivered with this product is only to be used by SAP's Support Services and may not be modified or altered in any way.

Documentation in SAP Developer Network (SDN)

You can find this documentation in SAP Developer Network (SDN) titled

Simple Use Cases for Communication between Advanced Adapter Engine Extended and PI Dual Stack.

1 Preface	4
2 Introduction and Prerequisites	4
2.1 Introduction.....	4
2.2 Prerequisites.....	5
2.2.1 General Prerequisites.....	5
2.2.2 Providing the necessary User and Authorizations	6
2.2.3 Setting Up the File Directories.....	6
2.2.4 Creating Communication Components in the Integration Directory of the Advanced Adapter Engine Extended	8
2.2.5 Creating Communication Components in the Integration Directory of the PI Dual Stack System.....	9
2.3 Design Objects Used	10
3 Variant 1: One Sender and One Receiver using communication between Advanced Adapter Engine Extended and PI Dual Stack system.....	11
3.1 Configuring the Process Integration Scenario in the Advanced Adapter Engine Extended	11
3.1.1 Design Objects Used.....	11
3.1.2 Configuring the scenario on the Advanced Adapter Engine Extended in Integration Directory	12
3.2 Configuring the Process Integration Scenario in the PI Dual Stack System	15
3.2.1 Design Objects Used.....	15
3.2.2 Configuring the scenario in the PI Dual Stack System.....	17
3.3 Executing the Use Case.....	20
4 Variant2: One Sender and One Receiver using communication between Advanced Adapter Engine Extended and PI Dual Stack System - using Exactly Once In Order	21
4.1 Configuring the Process Integration Scenario in the Advanced Adapter Engine Extended	22
4.1.1 Design Objects Used.....	22
4.1.2 Configuring the scenario on the Advanced Adapter Engine Extended in Integration Directory	22
4.2 Configuring the Process Integration Scenario in the PI Dual Stack System	25
4.2.1 Design Objects Used.....	25
4.2.2 Configuring the Process Integration Scenario in the PI Dual Stack System.....	26
4.3 Execution	28

1 Preface

Constraints

The texts, references, and graphics contained in this manual have been compiled with utmost care; nevertheless, it is impossible to guarantee that they are fully without error. SAP cannot assume any responsibility for the correctness or completeness of the following documentation; the user alone is responsible for verifying the information contained therein.

SAP will only assume liability for damage arising from the use of this documentation – irrespective of the pertinent legal basis – in the case of intentional or active negligence, under no other circumstances will a warranty be made.

Definition

This manual describes simple application cases for the Extended adapter engine for process integration and all the configuration steps that are necessary to execute the application cases on the basis of SAP NetWeaver.

Intended Audience

This manual is intended to be used by both technology and application consultants.

Structure

The structure of this document follows the sequence of steps required to configure and run the use cases.

Additional Documentation

List of related documentation

Documentation	Purpose
SAP NetWeaver Library documentation: Demo Examples	Introduction to demo examples and description of the process integration scenarios
SAP NetWeaver Documentation Simple Use Cases	Introduction to Simple Use Cases and description of the simple use case scenarios for Process Integration
Configuration of SAP NetWeaver Process Integration	Configuring usage type Advanced Adapter Engine Extended

This document is updated on a regular basis in SAP Developer Network (SDN) and is available as *Simple Use Cases for Communication between Advanced Adapter Engine Extended and PI Dual Stack*.

2 Introduction and Prerequisites

2.1 Introduction

Use cases are based on simple examples that enable you to learn the main features of Advanced Adapter Engine Extended. These instructions will enable you to understand, configure, and execute simple scenarios (that are based on message exchange between one AEX and one PI DS system along with other fundamental communication patterns), as well as check that the scenarios are executed correctly. The prerequisite for this document is that you have a general understanding of SAP NetWeaver Process Integration.

The following use case variants for the Advanced Adapter Engine Extended are available at present:

Variant	Description
Variants 1:	Represent message exchange between one sender on the Advanced Adapter Engine Extended and one receiver on the PI Dual Stack Server.
Variant 2:	Represents message exchange between one sender on the Advanced Adapter Engine Extended and one receiver on the PI Dual Stack Server using EOIO protocol.

You can aim to learn about the following with the use cases:

- Working with the Enterprise Services Builder – Enterprise Services Repository: Understanding existing design objects
- Working with the Integration Builder – Integration Directory: Configuring simple scenarios and understanding created configuration objects
- Working with the runtime: Executing the use cases and checking the results by using monitoring

SAP provides the required design objects and files for these learning targets. This document contains a complete set of instructions that enable you to configure and execute the use cases without any additional special prerequisites.



SAP NetWeaver Process Integration (Advanced Adapter Engine Extended) must be installed and configured, and be error free. In this respect, note the information under 2.2.1.

Within the scenarios file directories on the host of the SAP system on which the Advanced Adapter Engine Extended and the PI Dual Stack Server is installed serve as the senders and receivers of messages respectively. The use cases rely on file directories (and therefore the file/FTP adapter) to keep the technical prerequisites as simple as possible.

This document assumes that you will configure the variants **in succession**, in the order specified. While it is technically possible to configure the variants in a different order, doing so would mean that the order of the step-by-step instructions in this document would no longer be correct.



If you need to configure and execute the use cases as quickly as possible, skip the chapters concerning the design objects used and start instead with configuration. You can then return to the skipped chapters at a later stage for a better understanding of the various concepts.

2.2 Prerequisites

2.2.1 General Prerequisites

To configure and execute the use cases, SAP NetWeaver with usage type Process Integration and Advanced Adapter Engine Extended must be correctly installed and configured. The following table lists the prerequisites and the relevant guides:

List of required steps

Step	Documentation
------	---------------

<p>1. You have installed the Advanced Adapter Engine Extended and SAP NetWeaver 7.31(PI Dual Stack Server).</p>	<p><i>Master Guide – SAP NetWeaver</i> <i>Installation Guide – SAP Web AS ABAP and Java</i></p> <p>You can find the corresponding guides on SAP Service Marketplace in the Implementation Documentation Center for SAP NetWeaver 7.3 and SAP NetWeaver 7.3 including Enhancement Package 1</p>
<p>2. You have imported the content for the Enterprise Services Repository corresponding to the latest support package/patch into the PI Dual Stack System and the Advanced Adapter Engine Extended System.</p>	<p>SAP Note 836200</p>  <p>The simple use cases are located in the Enterprise Services Repository in the software component <i>SAP BASIS</i>, software component version <i>SAP BASIS 7.31</i>, in the namespaces http://sap.com/xi/XI/System/Patterns.</p>
<p>3. You have configured the Advanced Adapter Engine Extended and SAP NetWeaver Process Integration.</p>	<p>Configuration of SAP NetWeaver Process Integration</p>
<p>4. You have configured the System Landscape Directory (SLD) for the PI Dual Stack System and the Advanced Adapter Engine Extended System.</p>	<p>Configuring, Working with and Administering System Landscape Directory</p>



Note that you set up the use cases in your development or test system, but **not** in your productive system.

2.2.2 Providing the necessary User and Authorizations

To log on to the SAP system to configure the simple use cases, you have to create a user *XIDEMO* with the following roles in the integration server client (001) of PI Dual Stack System **and** in the Advanced Adapter Engine Extended:

- SAP_XI_ADMINISTRATOR
- SAP_XI_CONFIGURATOR
- SAP_XI_MONITOR
- SAP_XI_DEMOAPP

2.2.3 Setting Up the File Directories

The variants are based on a very simple system landscape that comprises various different file systems (on the host of the SAP system on which the Advanced Adapter Engine Extended and on the host where the PI Dual Stack Server is installed). When the use cases

are executed, files are moved between file directories. Therefore, to be able to configure the use cases, the file directories must have been created and described in the System Landscape Directory. Only then can you access the directories during configuration in the Integration Directory.

Perform the steps below to create the required directories on the host of the SAP system on which the Advanced Adapter Engine Extended is installed.

1. Open the file directory of the SAP system, on which the Advanced Adapter Engine Extended is installed.

For Example using Windows Explorer on Windows Systems.

2. Create a directory in which you can save files temporarily and create sub directories XiPatterns_AAEX and XiPatternsO_AAEX in it.



A work directory already exists on many computers that can be used for this purpose and under which you can create the required directories.

3. Create further sub directory in the sub directory XiPatterns_AAEX. Suggested name: XiPattern6.
4. Create further sub directory in the sub directory XiPatternsO_AAEX. Suggested name: XiPattern8.



You must have authorization to access this directory to be able to test the process integration scenario. Bear this in mind when you define the directory, and, if applicable, contact your system administrator.

5. Copy the following file to directory *XiPattern6*
 - *ZXiPatternSenderFile1.xml*
6. Copy the following file to directory *XiPattern8*
 - XiPatternSenderFilesEOIO.zip (This file contains 1000 xml files for the EOIO scenario; they will be unpacked when executing the scenario.)



These files are provided by SAP in a ZIP file. The ZIP file for 7.31 containing also the EOIO test files is available in SAP Developer Network (SDN) and can be found using the direct link [EHP 1 for SAP NetWeaver Process Integration 7.3 – Test Files for Simple Use Cases](#).

Perform the steps below to create the required directories on the host of the SAP system on which the PI Dual Stack Server is installed.

1. Open the file directory of the SAP system on which the Integration Server is installed.
For Example using Windows Explorer on Windows Systems.
2. Create a directory in which you can save files temporarily and create sub directories XiPatterns_AAEX and XiPatternsO_AAEX in it.



A work directory already exists on many computers that can be used for this purpose and under which you can create the required directories.

3. Create a sub directory in the sub directory XiPatterns_AAEX. Suggested name: XiPattern7.
4. Create a sub directory in the sub directory XiPatternsO_AAEX. Suggested name: XiPattern9.



You must have authorization to access this directory to be able to test the process integration scenario. Bear this in mind when you define the directory, and, if applicable, contact your system administrator.

2.2.4 Creating Communication Components in the Integration Directory of the Advanced Adapter Engine Extended

In the following steps you define communication components in the Advanced Adapter Engine Extended. You need to create communication components to be able to address as senders/receivers of messages when you configure the process integration scenario in the Integration Directory.

You define communication components in the Integration Directory of the Advanced Adapter Engine Extended.

Therefore, to execute the activities described below, call the Integration Builder (user interface of Integration Directory).

1. To call the Integration Directory for the Advanced Adapter Engine Extended System, open the Advanced Adapter Engine Extended Start Page using the URL:
`http(s)://<AAEX-Host>:<AAEX-Port>/dir.`
2. On the Advanced Adapter Engine Extended Start Page, choose the hyperlink *Integration Builder* (under *Integration Directory*).
3. Log on using the XIDEMO user you created in 2.2.2. The system opens the Integration Builder.

You use the steps below to define a communication component in the Integration Directory.

1. In the Integration Builder navigation area, on the *Objects* tab page, position the cursor on the *Communication Components Without Party* node.
2. To call the wizard for assigning business systems, choose *New Business Component* in the context menu.
3. On the next screen, enter `<SID>_AAEX_BusComponent_XiPattern6` for the field Communication System Component. `<SID>` is the system ID of the Advanced Adapter Engine Extended System
4. Click Create.
5. On the next screen, click on Save. Communication Component for Sender – Advanced Adapter Engine Extended is created.
6. Following the above steps, create three more Communication Component:
 - `<SID>_AAEX_BusComponent_XiPattern8` - `<SID>` is the system ID of the Advanced Adapter Engine Extended System
 - `<SID>_PI_BusComponent_XiPattern7` - `<SID>` is the system ID of the PI Dual Stack System
 - `<SID>_PI_BusComponent_XiPattern9` - `<SID>` is the system ID of the PI Dual Stack System

Perform the following steps to activate the communication components.

1. In the navigation area, choose the *Change Lists* tab page.
2. Choose *Open* → *Standard Change List*.
3. Check that the five communication components you just created are contained in the change list.
4. Position the cursor on the *Standard Change List* node and choose *Activate* () in the context menu.

2.2.5 Creating Communication Components in the Integration Directory of the PI Dual Stack System

In the following steps you define communication components on the PI Dual Stack system for the business systems you just created. You need to create communication components to be able to address the business systems as senders/receivers of messages when you configure the process integration scenario in the Integration Directory. For Variants included below, the communication components need to be known in the Advanced Adapter Engine Extended and in the PI Dual Stack System as messages are exchanges between both.

To prepare the configuration of the process integration scenario, you must do the following:

- Define the involved systems as communication components in the Integration Directory
Only then can you address the business components as senders or receivers of messages.
- Define communication channels for outbound message processing (for all relevant receiver communication components)

You define communication components in the Integration Directory.

Therefore, to execute the activities described below, call the Integration Builder (user interface of Integration Directory).

1. To call the Integration Builder, in the SAP System of the Integration Server choose *Process Integration* → *Start Integration Builder* in the user menu.
2. On the initial screen, choose the hyperlink *Integration Builder* (under *Integration Directory*).
3. Log on using the XIDEMO user you created in 2.2.2. The system opens the Integration Builder.

You use the steps below to define a communication component in the Integration Directory.

1. In the Integration Builder navigation area, on the *Objects* tab page, position the cursor on the *Communication Components Without Party* node.
2. To call the wizard for assigning business systems, choose *New Business Component* in the context menu.
3. On the next screen, enter `<SID>_AAEX_BusComponent_XiPattern6` for the field Communication Component. `<SID>` is the system ID of the Advanced Adapter Engine Extended System
4. Click Create.
5. On the next screen, click on Save. Communication Component for Sender – Advanced Adapter Engine Extended is created.
6. Following the above steps, create three more Communication Component:
 - `<SID>_AAEX_BusComponent_XiPattern8` - `<SID>` is the system ID of the Advanced Adapter Engine Extended System

- <SID>_PI_BusComponent_XiPattern7 - <SID> is the system ID of the PI Dual Stack System
- <SID>_PI_BusComponent_XiPattern9 - <SID> is the system ID of the PI Dual Stack System

Perform the following steps to activate the communication components.

1. In the navigation area, choose the *Change Lists* tab page.
2. Choose *Open* → *Standard Change List*.
3. Check that the five communication components you just created are contained in the change list.
4. Position the cursor on the *Standard Change List* node and choose *Activate* () in the context menu.

2.3 Design Objects Used



This section explains all the design objects that are used for describing the variants.

The subsequent description of each variant will refer to the description in this section; the relevant design objects will only be listed briefly in each case.

Process Integration Scenario/Component View

A process integration scenario describes the process flow and represents the points in the process flow at which messages are exchanged between application components (in this case, the application components *Sender* and *Receiver*). Component View *File2File_NoMapping* represents the variant with message exchange between Advanced Adapter Engine Extended and the PI Dual Stack System, whereas the Component View *File2File_NoMapping_InOrder* represents the variant with message exchange in EOIO. The variants only running locally in the Advanced Adapter Engine Extended are not based on component views because they are using the integrated configuration.

Interface Objects

Interface objects describe the communication mode and the data structure for exchanging messages. Interface objects comprise service interfaces, message types, and data types, which you can open by means of forward navigation, starting with the Service Interfaces.

Mapping Objects

If the interfaces at the sender and receiver are different, a mapping is required.

Communication Channel Templates

You use communication channel templates to define details, which were defined when the process integration scenario was defined, for the inbound or outbound processing of the message. You can then use the communication channel template to create the corresponding communication channel when configuring in the Integration Directory. You then need to specify all the details, which are only known at configuration time, in the communication channel.

The specific design objects will be listed in the specific variants below.

3 Variant 1: One Sender and One Receiver using communication between Advanced Adapter Engine Extended and PI Dual Stack system

This variant enables you to configure and execute the simplest kind of message exchange:

One sender (file directory *XiPattern1*) sends a message to one receiver (file directory *XiPattern2*). Hereby, the message is exchanged between a sender file adapter on the Advanced Adapter Engine Extended and a receiver file adapter on the PI Dual Stack system. No mapping is executed between the outbound and inbound interface in this variant. The Advanced Adapter Engine Extended sends the file to PI Dual Stack using SOAP over XI protocol.

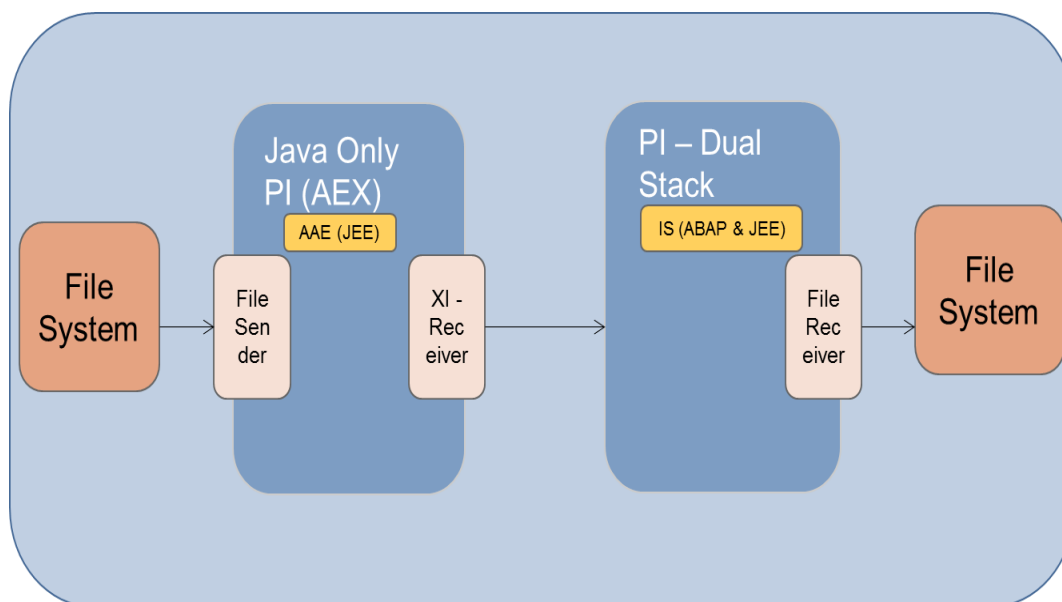

3.1 Configuring the Process Integration Scenario in the Advanced Adapter Engine Extended

3.1.1 Design Objects Used

The design objects used are summarized in the following table.



For a general description of the various object types, see SAP Help Portal at:

[Enterprise Services Repository](#)

Design Objects Used

Object Type (Name)	Description
Service Interface (<i>XiPatternInterface1</i>)	Specifies the communication mode (asynchronous) and references the message type used.
Message Type (<i>XiPatternMessage1</i>)	Describes the message sent at runtime and references the data type used.

Data Type (<i>XiPatternDataType1</i>)	Describes the data structure of the message
Communication Channel Templates for Sender and Receiver (<i>XiPatternChannel_FileSender</i> , <i>XiPatternChannel_XiReceiver</i> , <i>XiPatternChannel_FileReceiver</i>)	Specifies the sender (and receiver) adapter configuration details, which are defined at design time. Communication channel templates enable a communication channel to be preconfigured at design time.

3.1.2 Configuring the scenario on the Advanced Adapter Engine Extended in Integration Directory

You perform the following configuration steps in the Integration Directory of the Advanced Adapter Engine Extended.

For this scenario, the integrated configuration object is used for configuration.



For more information, see [Defining the Integrated Configuration](#).

Calling the Integration Directory

First, call the Integration Directory. To call the Integration Directory for the Advanced Adapter Engine Extended System, open the Advanced Adapter Engine Extended Start Page using the URL: [http\(s\)://<AAEX-Host>:<AAEX-Port>/dir](http(s)://<AAEX-Host>:<AAEX-Port>/dir).

Creating a Configuration Scenario

To configure this variant, a new configuration scenario is created.

Selecting the Process Integration Scenario

Perform the following steps to select the process integration scenario that you want to configure from the Enterprise Services Repository. Also, enter the name of the *configuration scenario* (in the Integration Directory) in which you want to group the configuration objects.

- To call the model configurator, choose *Tools* → *Apply Model from ES Repository* in the Integration Builder menu bar.
This calls a wizard, which you use to select a model (in this case, a process integration scenario) and create a configuration scenario in the Integration Directory.
- Make sure that the model type *Process Integration Scenario* is selected (radio button under *Type of ES Repository Model*).
- Choose the input help (for the *Name* field) ()
This calls an input help, which displays all process integration scenarios from the Enterprise Services Repository in a list.
- Select the process integration scenario *XiPatternOneStepScenario* (software component version *SAP BASIS 7.31*, namespace <http://sap.com/xi/XI/System/Patterns>) from the Enterprise Services Repository and choose *Apply*.
- Choose *Continue*.
- Enter the name of the configuration scenario as:
`XiPatternOneStepScenario_AAEX_PI`.
- Choose *Finish* and then *Close*.



The system calls the model configurator.

Selecting the Component View

Check whether the component view *File2File_NoMapping* is displayed. If it is not, choose the menu option *Select Component View* (). On the subsequent screen, select the component view (in the preview area) by double-clicking.

Assigning Communication Components

You perform the following steps to assign communication components to the application components of the process integration scenario. You use the business components that you created before (see [2.2.4](#)).

1. In the graphical editor, click on the lane representing the *Sender* application component.
This calls the *Assign Business System Component* dialog box for the *Sender* application component (below the graphical representation of the process integration scenario).
2. To assign a communication component click in the input field in the *Communication Component* column and call the input help ().
3. By default the search criteria is filtered for Business system. Change it to Business Component and Refresh. All the Business Component will be displayed now.
4. Select the communication component <SID>_AAEX_BusComponent_XiPattern6 and then choose *Apply*.
5. Choose *Next Role* () to navigate to the configuration dialog for the application component *Receiver*.
6. Assign the communication component <SID>_PI_BusComponent_XiPattern7 to the application component *Receiver*. Follow the same procedure as when assigning the communication component to the application component *Sender*.
7. Choose *Assign*.

Configuring the Connection

You perform the following steps to configure the connection of the process integration scenario. You activate the relevant sender-receiver relation (between the sender and receiver component) and assign both the sender and receiver a (sender or receiver) communication channel. You create the communication channel on the basis of the communication channel templates that the process integration scenario already contains.

1. In the graphical editor, click on the connection between the lanes representing the two application components.
2. This calls the *Configure Connection* dialog box for the connection between the actions (below the graphical representation of the process integration scenario).
3. On the *Configure Connections* screen, choose the tab page *Connections from Component Assignment*. The communication components that you assigned in the previous configuration step are displayed.



The remaining tab pages contain further information about the process integration scenario, for example, the communication channel templates that are defined for the process integration scenario in the Enterprise Services Repository.

4. Assign the sender a communication channel. To do so, place the cursor in the field *Communication Channel for the Sender Component*, in the push button bar choose  |

→ *Create Communication Channel With Template* (). In the subsequent wizard you can create a communication channel based on a communication channel template.

5. Choose *Continue*.

The default communication channel template on the subsequent screen is that which was assigned to the sender application component in the process integration scenario (name *XiPatternChannel_FileSender*, software component version *SAP BASIS 7.31*, namespace <http://sap.com/xi/XI/System/Patterns>).

6. Choose *Continue*.

The default name for the communication channel on the next screen is *XiPatternChannel_FileSender*.

7. Confirm your selection by choosing *Finish*.

8. Following the same procedure (see step 4-7), assign the application component of the receiver a communication channel (*XiPatternChannel_XiReceiver*) based on the default communication channel template (name *XiPatternChannel_XiReceiver*, software component version *SAP BASIS 7.31*, namespace <http://sap.com/xi/XI/System/Patterns>).

Generating the Configuration Objects

In the following steps, you generate the relevant configuration objects based on the settings made in previous steps.

1. If not already selected, select the flag for *Configuration for Advanced Adapter Engine*.
2. Choose the push button *Create Configuration Objects* ().
3. Under *General*, select the radio button *Generation*.
4. Choose *Start*.

The integrated configuration objects are generated based on the settings you made. Once generation is complete, the generation log is opened. The generation log displays the results of generation. The generation log enables you to analyze any errors that occurred during generation.
5. Close the generation log.
6. Close the model configurator. Choose *Apply*.
7. Save the configuration scenario.

Manual Editing

In the following steps, you edit the generated configuration objects manually and enhance the configuration settings made during generation. In this variant, you must edit the communication channels after generation.

1. In the editor *Display Configuration Scenario* (for the open scenario *XiPatternOneStepScenario_AAEX_PI*), on the tab page *Objects* open the communication channel () *XiPatternChannel_FileSender* by double-clicking.
2. Under *File Access Parameter* in the *Source Directory* field, enter the path in the file directory that you defined previously (see [2.2.3](#)). In the case of the sender communication channel, enter the whole path for the file directory *XiPattern6*.
Example: `C:/<selected path>/XiPatterns_AAEX/XiPattern6`
3. Save the communication channel.
4. Following the same procedure, edit the communication channel *XiPatternChannel_XiReceiver* (communication component `<SID>_PI_BusComponent_XiPattern7`).

5. Enter the URL to the Integration Server as Target URL (for example `http(s)://<PI Dual Stack-host>:<PI Dual Stack-port>/sap/xi/engine?type=entry`). As *User Name* set `PIAPPLUSER` (or a copy of the `PIAPPLUSER`) with the respective *User Password* in the Integration Server Client, in field *Logon Client* set the client of the integration server (e.g. 001).
6. Save the communication channel.

Activating the Change List

1. To do this, select the *Change Lists* tab page in the Integration Directory navigation area.
2. Choose *Open* → *Standard Change List*.
3. Position the cursor on the *Standard Change List* node and choose *Activate* (🔧) in the context menu.

3.2 Configuring the Process Integration Scenario in the PI Dual Stack System

To enable message flow between the Advanced Adapter Engine Extended and the PI System you also need to do the configuration in the PI System.

3.2.1 Design Objects Used



This section explains all the design objects that are used for describing this variant. There is a step-by-step description of how to access each object. SAP recommends that you follow these steps directly in the system.

You use the component view *File2File_NoMapping* in process integration scenario *XiPatternOneStepScenario* to configure this variant in the PI Dual Stack System. The following graphic shows the component view:

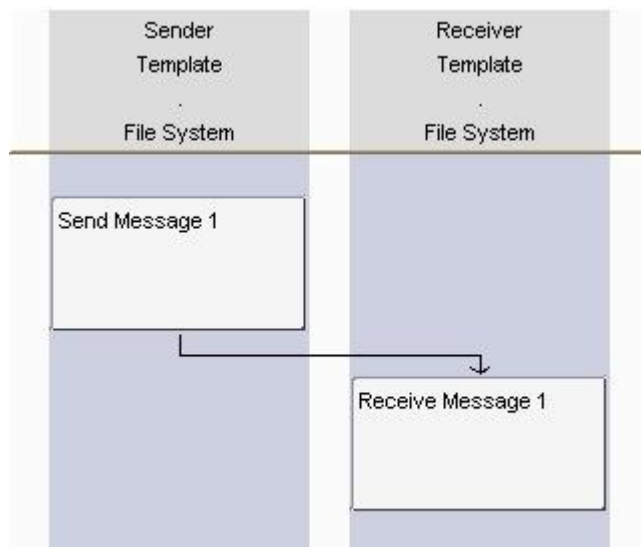

SAP NetWeaver Process Integration, Process Integration Scenario Editor

The following describes all the objects that describe the message exchange in this variant in turn. Starting with the process integration scenario (component view), you can open all the objects that the component view uses.

1. To call the Enterprise Services Builder (user interface of the Enterprise Services Repository), choose *Process Integration* → *Start Integration Builder* in the user menu.
2. On the *Process Integration* initial screen, choose *Enterprise Services Builder* under *Enterprise Services Repository*.
3. In the navigation area, open the software component *SAP BASIS*, software component version *SAP BASIS 7.31*, and namespace *http://sap.com/xi/XI/System/Patterns*.
4. Open the node *Process Integration Scenarios*.
5. Open process integration scenario *XiPatternOneStepScenario* by double-clicking.
The process integration scenario editor is opened.

Process Integration Scenario/Component View

A process integration scenario describes the process flow and represents the points in the process flow at which messages are exchanged between application components (in this case, the application components *Sender* and *Receiver*). Specific communication variants are represented by different component views. Component View *File2File_NoMapping* represents the used variant.

Ensure that component view *File2File_NoMapping* is displayed in the graphical editor. If it is not displayed, choose the component view in the preview area on the left by double-clicking. The component view comprises two actions *Send Message 1* and *Receive Message 1*, which are linked by an asynchronous communication step (angled arrow).

Interface Objects

Interface objects describe the communication mode and the data structure for exchanging messages. Interface objects comprise service interfaces, message types, and data types, which you can open by means of forward navigation, starting in the component view.

1. To open the interface objects used, double-click the connecting arrow in the component view.

The connection editor is displayed.

The service interfaces for the sender and receiver are displayed on the *Assign Interfaces* tab page: in the case of the sender, it is the outbound interface *XiPatternInterface1* and in the case of the receiver, it is the same inbound interface *XiPatternInterface1*. Since the interface is the same for both the sender and receiver, no mapping is required.

2. To open the service interface *XiPatternInterface1*, double-click the interface name.
3. In the *Service Interface* editor you can see that it is an abstract interface.

The interface is *abstract* because the interface description is not implemented in the relevant software component.

4. To open the message type, double-click the name of the message type *XiPatternMessage1* (in the service interface editor under *Messages*).

In the *Message Type* editor, you can display the data structure of the message. The data structure is defined by the data type *XiPatternDataType1*.

Information about a person is structured by different elements in the data structure of the exchanged message. Details such as the maximum character length are displayed in the *Details* column.

Communication Channel Templates

You use communication channel templates to define details, which were defined when the process integration scenario was defined, for the inbound or outbound processing of the message. You can then use the communication channel template to create the corresponding communication channel when configuring in the Integration Directory. You

then need to specify all the details, which are only known at configuration time, in the communication channel.

1. To open a communication channel template (for example, for the sender), double-click the name. Further details are displayed in the *Display Communication Channel Template* editor.
2. Close all objects and the process integration scenario.

Summary of Design Objects Used

The design objects used are summarized once more in the following table.



For a general description of the various object types, see SAP Help Portal at:

[Enterprise Services Repository](#)

Design Objects Used

Object Type (Name)	Description
Process Integration Scenario (<i>XiPatternOneStepScenario</i>)	Describes the process flow and indicates the points at which messages are exchanged between the different components. The component view <i>File2File_NoMapping</i> in particular describes all variants in which no mapping is executed (interfaces at the sender and receiver are identical).
Service Interface (<i>XiPatternInterface1</i>)	Specifies the communication mode (asynchronous) and references the message type used.
Message Type (<i>XiPatterMessage1</i>)	Describes the message sent at runtime and references the data type used.
Data Type (<i>XiPatternDataType1</i>)	Describes the data structure of the message
Communication Channel Templates for Sender and Receiver (<i>XiPatternChannel_FileReceiver</i>)	Specifies the receiver adapter configuration details, which is defined at design time. Communication channel template enable a communication channel to be preconfigured at design time.

3.2.2 Configuring the scenario in the PI Dual Stack System

You perform the following configuration steps in the Integration Directory of the PI Dual Stack System. This configuration is needed as the message exchange is done from the Advanced Adapter Engine Extended system to the receiver adapter in the PI Dual Stack System.



Note the prerequisite steps described in section 2.2.

In configuration, you translate the process described by the process integration scenario (component view) to an actual system landscape. You have already described the system landscape in the SLD. The communication components you defined earlier enable you to address the involved business systems as senders/receivers of messages in the Integration Directory.

You use the model configurator for the whole configuration procedure. This tool enables you to use a process integration scenario from the Enterprise Services Repository as a

configuration template and to add further information (which is not known until configuration time).

Calling the Integration Directory

First, call the Integration Directory (transaction SXMB_IFR) on the PI Dual Stack System. On the *Process Integration* initial screen, choose hyperlink *Integration Builder* (under *Integration Directory*).

Selecting the Process Integration Scenario

Perform the following steps to select the process integration scenario that you want to configure from the Enterprise Services Repository. Also, enter the name of the *configuration scenario* (in the Integration Directory) in which you want to group the configuration objects.

1. To call the model configurator, choose *Tools* → *Apply Model from ES Repository* in the Integration Builder menu bar.

This calls a wizard, which you use to select a model (in this case, a process integration scenario) and create a configuration scenario in the Integration Directory.

2. Make sure that the model type *Process Integration Scenario* is selected (radio button under *Type of ES Repository Model*).

3. Choose the input help (for the *Name* field) ().

This calls an input help, which displays all process integration scenarios from the Enterprise Services Repository in a list.

4. Select the process integration scenario *XiPatternOneStepScenario* (software component version *SAP BASIS 7.31*, namespace *http://sap.com/xi/XI/System/Patterns*) from the Enterprise Services Repository and choose *Apply*.

5. Choose *Continue*.

6. Enter the name of the configuration scenario as:
`XiPatternOneStepScenario_AAEX_PI`.

7. Choose *Finish* and then *Close*.

The system calls the model configurator.

Selecting the Component View

Check whether the component view *File2File_NoMapping* is displayed. If it is not, choose the menu option *Select Component View* (). On the subsequent screen, select the component view (in the preview area) by double-clicking.

Assigning Communication Components

You perform the following steps to assign communication components to the application components of the process integration scenario. You use the business components that you created before (see [2.2.5](#)).

1. In the graphical editor, click on the lane representing the *Sender* application component.

This calls the *Assign Business System Component* dialog box for the *Sender* application component (below the graphical representation of the process integration scenario).

2. To assign a communication component click in the input field in the *Communication Component* column and call the input help ().

3. By default the search criteria is filtered for Business system. Change it to Business Component and Refresh. All the Business Component will be displayed now

4. Select the communication component <SID>_AAEX_BusComponent_XiPattern6 and then choose *Apply*.
5. Choose *Next Role* (➔) to navigate to the configuration dialog for the application component *Receiver*.
6. Assign the communication component <SID>_PI_BusComponent_XiPattern7 to the application component *Receiver*. Follow the same procedure as when assigning the communication component to the application component *Sender*.
7. Choose *Assign*.



Configuring the Connection

You perform the following steps to configure the connection of the process integration scenario. You activate the relevant sender-receiver relation (between the sender and receiver component) and assign both the sender and receiver a (sender or receiver) communication channel. You create the communication channel on the basis of the communication channel templates that the process integration scenario already contains.

1. In the graphical editor, click on the connection between the lanes representing the two application components.
2. This calls the *Configure Connection* dialog box for the connection between the actions (below the graphical representation of the process integration scenario).
3. On the *Configure Connections* screen, choose the tab page *Connections from Component Assignment*. The communication components that you assigned in the previous configuration step are displayed.



The remaining tab pages contain further information about the process integration scenario, for example, the communication channel templates that are defined for the process integration scenario in the Enterprise Services Repository.

4. Assign the receiver a communication channel. To do so, place the cursor in the field *Communication Channel for the Receiver Component*, in the push button bar choose  → *Create Communication Channel With Template* (). In the subsequent wizard you can create a communication channel based on a communication channel template.
5. Choose *Continue*.

The default communication channel template on the subsequent screen is that which was assigned to the sender application component in the process integration scenario (name *XiPatternChannel_FileReceiver*, software component version *SAP BASIS 7.31*, namespace *http://sap.com/xi/XI/System/Patterns*).

6. Choose *Continue*.

The default name for the communication channel on the next screen is *XiPatternChannel_FileReceiver*.

7. Confirm your selection by choosing *Finish*.

Generating the Configuration Objects

In the following steps, you generate the relevant configuration objects based on the settings made in previous steps.

1. Choose the push button *Create Configuration Objects* ().
2. Under *General*, select the radio button *Generation*.

3. Choose *Start*.
The configuration objects are generated based on the settings you made. Once generation is complete, the generation log is opened. The generation log displays the results of generation. The generation log enables you to analyze any errors that occurred during generation.
4. Close the generation log.
5. Close the model configurator. Choose *Apply*.
6. Save the configuration scenario.

Manual Editing

In the following steps, you edit the generated configuration objects manually and enhance the configuration settings made during generation. In this variant, you must edit the communication channels after generation.

1. In the editor *Display Configuration Scenario* (for the open scenario *XiPatternOneStepScenario*), on the tab page *Objects* open the communication channel () *XiPatternChannel_FileReceiver* by double-clicking.
2. Change to *Edit Mode*.
3. Under *File Access Parameter* in the *Target Directory* field, enter the path in the file directory that you defined previously (see [2.2.3](#)). In the case of the receiver communication channel, enter the whole path for the file directory on the PI Integration Server *XiPattern7*.
Example: C:/<selected path>/XiPatterns_AAEX/XiPattern7
4. Save the communication channel.

Activating the Change List

1. To do this, select the *Change Lists* tab page in the Integration Directory navigation area.
2. Choose *Open* → *Standard Change List*.
3. Position the cursor on the *Standard Change List* node and choose *Activate* () in the context menu.

3.3 Executing the Use Case

You perform the following steps to check that the use case is executed without errors.

1. On the host of the Advanced Adapter Engine Extended, open the file directory *XiPattern6*.
2. Rename the file `ZXiPatternSenderFile1.xml` as `XiPatternSenderFile1.xml`.
The File/FTP adapter is designed in a way that a file with exactly this name is recognized and moved from the source directory *XiPattern6* to the target directory on the PI System *XiPattern7* every 60 seconds. If the configuration was executed without errors, the file will be moved from the source directory within 60 seconds after it is renamed.
3. Open the directory *XiPattern7* on the *PI Dual Stack Server* and check that the file has arrived.
4. Open the file and check whether the content has changed (compare with the original file *ZXiPatternSenderFile1.xml*).

The file must not have been changed when this variant is executed.

Furthermore, you can check the processing in the message in monitoring. To do this, proceed as follows:

1. Start the Monitoring by choosing *Configuration and Monitoring Home* on the Advanced Adapter Engine Extended start page.
2. Choose *Message Overview*.
3. Select *Database*.
4. Use appropriate filter criteria to restrict the number of XML messages displayed (for example, the processing period).
5. Choose *Go*.

The system displays the selected messages in a table. You want to locate the messages that were sent during execution.

6. Select the message to be displayed by selecting the appropriate radio button and then choose *Open Message*.

The tab *Payloads* displays the message contents for the various versions of the message during processing.

7. The processing in the PI Dual Stack System needs to be checked in the Message Monitoring in the PI Dual Stack System. Start the Monitoring by choosing *Configuration and Monitoring Home* on the PI Dual Stack Start Page and follow the steps described above to find the message on the PI Dual Stack System.

4 Variant2: One Sender and One Receiver using communication between Advanced Adapter Engine Extended and PI Dual Stack System - using Exactly Once In Order

This variant enables you to configure and execute the simplest kind of message exchange: one sender on the Advanced Adapter Engine Extended (file directory *XiPatterns8*) sends a series of messages to one receiver on the PI Dual Stack System (file directory *XiPatterns9*). No mapping is executed between the outbound and inbound interface in this variant. The messages are delivered in some particular order. Concretely, the file adapter allows either the last-modified timestamp or the filename to be used to order the input files in its directory. The Advanced Adapter Engine Extended sends all the files to PI Dual Stack using SOAP over XI protocol.

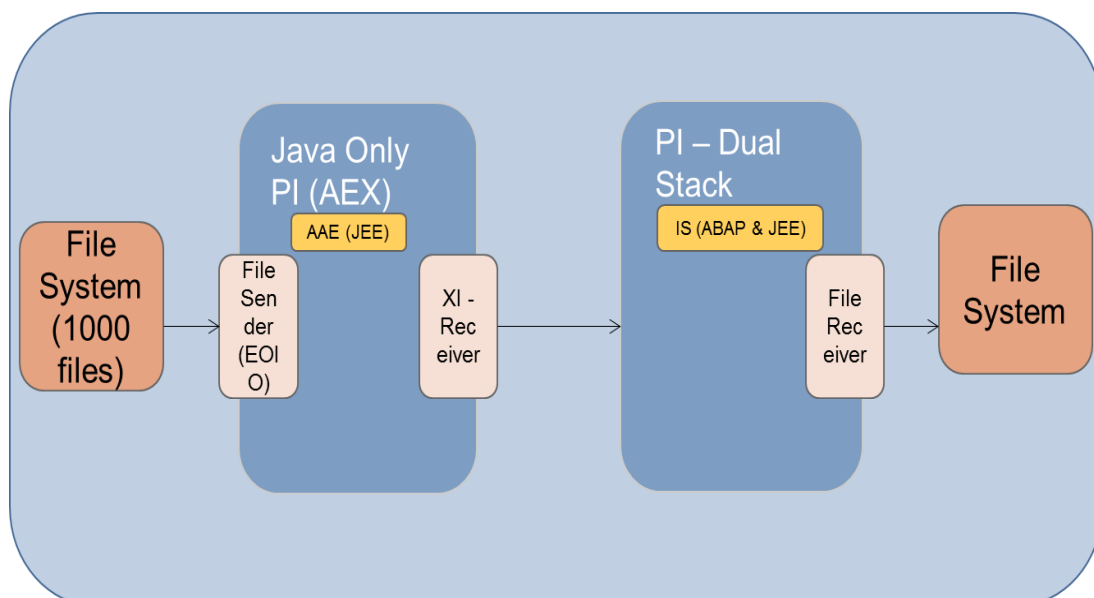

4.1 Configuring the Process Integration Scenario in the Advanced Adapter Engine Extended

4.1.1 Design Objects Used

The design objects used are summarized in the following table.



For a general description of the various object types, see SAP Help Portal at: [Enterprise Services Repository](#)

Design Objects Used

Object Type (Name)	Description
Service Interface (<i>XiPatternInterface10</i>)	Specifies the communication mode (asynchronous) and references the message type used.
Message Type (<i>XiPattermMessage1</i>)	Describes the message sent at runtime and references the data type used.
Data Type (<i>XiPatternDataType1</i>)	Describes the data structure of the message
Communication Channel Templates for Sender and Receiver (<i>XiPatternChannel_FileSenderO</i> , <i>XiPatternChannel_XiReceiver</i> , <i>XiPatternChannel_FileReceiverO</i>)	Specifies the sender (and receiver) adapter configuration details, which are defined at design time. Communication channel templates enable a communication channel to be preconfigured at design time.

4.1.2 Configuring the scenario on the Advanced Adapter Engine Extended in Integration Directory

You perform the following configuration steps in the Integration Directory of the Advanced Adapter Engine Extended.

For this scenario, the integrated configuration object is used for configuration.



For more information, see [Defining the Integrated Configuration](#).

Calling the Integration Directory

First, call the Integration Directory. To call the Integration Directory for the Advanced Adapter Engine Extended System, open the Advanced Adapter Engine Extended Start Page using the URL: [http\(s\)://<AAEX-Host>:<AAEX-Port>/dir](http(s)://<AAEX-Host>:<AAEX-Port>/dir).

Creating a Configuration Scenario

To configure this variant, a new configuration scenario is created.

Selecting the Process Integration Scenario

Perform the following steps to select the process integration scenario that you want to configure from the Enterprise Services Repository. Also, enter the name of the *configuration scenario* (in the Integration Directory) in which you want to group the configuration objects.

1. To call the model configurator, choose *Tools* → *Apply Model from ES Repository* in the Integration Builder menu bar.
 This calls a wizard, which you use to select a model (in this case, a process integration scenario) and create a configuration scenario in the Integration Directory.
2. Make sure that the model type *Process Integration Scenario* is selected (radio button under *Type of ES Repository Model*).
3. Choose the input help (for the *Name* field) ().
 This calls an input help, which displays all process integration scenarios from the Enterprise Services Repository in a list.
4. Select the process integration scenario *XiPatternOneStepScenario* (software component version *SAP BASIS 7.31*, namespace <http://sap.com/xi/XI/System/Patterns>) from the Enterprise Services Repository and choose *Apply*.
5. Choose *Continue*.
6. Enter the name of the configuration scenario as:
`XiPatternOneStepScenario_AAEX_PI_EOIO`.
7. Choose *Finish* and then *Close*.



The system calls the model configurator.

Selecting the Component View

Check whether the component view *File2File_NoMapping_InOrder* is displayed. If it is not, choose the menu option *Select Component View* (). On the subsequent screen, select the component view (in the preview area) by double-clicking.

Assigning Communication Components

You perform the following steps to assign communication components to the application components of the process integration scenario. You use the business components that you created before (see [2.2.4](#)).

1. In the graphical editor, click on the lane representing the *Sender* application component.
 This calls the *Assign Business System Component* dialog box for the *Sender* application component (below the graphical representation of the process integration scenario).
2. To assign a communication component click in the input field in the *Communication Component* column and call the input help ().
3. By default the search criteria is filtered for Business system. Change it to Business Component and Refresh. All the Business Component will be displayed now.
4. In the subsequent screen, select the communication component `<SID>_AAEX_BusComponent_XiPattern8` and then choose *Apply*.
5. Choose *Next Role* () to navigate to the configuration dialog for the application component *Receiver*.
6. Assign the communication component `<SID>_PI_BusComponent_XiPattern9` to the application component *Receiver*. Follow the same procedure as when assigning the communication component to the application component *Sender*.
7. Choose *Assign*.



Configuring the Connection

You perform the following steps to configure the connection of the process integration scenario. You activate the relevant sender-receiver relation (between the sender and receiver component) and assign both the sender and receiver a (sender or receiver) communication channel. You create the communication channel on the basis of the communication channel templates that the process integration scenario already contains.

1. In the graphical editor, click on the connection between the lanes representing the two application components.
2. This calls the *Configure Connection* dialog box for the connection between the actions (below the graphical representation of the process integration scenario).
3. On the *Configure Connections* screen, choose the tab page *Connections from Component Assignment*. The communication components that you assigned in the previous configuration step are displayed.



The remaining tab pages contain further information about the process integration scenario, for example, the communication channel templates that are defined for the process integration scenario in the Enterprise Services Repository.

4. Assign the sender a communication channel. To do so, place the cursor in the field *Communication Channel for the Sender Component*, in the push button bar choose  → *Create Communication Channel With Template* (). In the subsequent wizard you can create a communication channel based on a communication channel template.
5. Choose *Continue*.
The default communication channel template on the subsequent screen is that which was assigned to the sender application component in the process integration scenario (name *XiPatternChannel_FileSenderO*, software component version *SAP BASIS 7.31*, namespace <http://sap.com/xi/XI/System/Patterns>).
6. Choose *Continue*.
The default name for the communication channel on the next screen is *XiPatternChannel_FileSenderO*.
7. Confirm your selection by choosing *Finish*.
8. Following the same procedure (see step 4-7), assign the application component of the receiver a communication channel (*XiPatternChannel_XiReceiver*) based on the default communication channel template (name *XiPatternChannel_XiReceiver*, software component version *SAP BASIS 7.31*, namespace <http://sap.com/xi/XI/System/Patterns>).

Generating the Configuration Objects

In the following steps, you generate the relevant configuration objects based on the settings made in previous steps.

1. If not already selected, select the flag for *Configuration for Advanced Adapter Engine*.
2. Choose the push button *Create Configuration Objects* (.
3. Under *General*, select the radio button *Generation*.
4. Choose *Start*.
The integrated configuration objects are generated based on the settings you made. Once generation is complete, the generation log is opened. The generation log displays the results of generation. The generation log enables you to analyze any errors that occurred during generation.

5. Close the generation log.
6. Close the model configurator. Choose *Apply*.
7. Save the configuration scenario.

Manual Editing

In the following steps, you edit the generated configuration objects manually and enhance the configuration settings made during generation. In this variant, you must edit the communication channels after generation.

1. In the editor *Display Configuration Scenario* (for the open scenario *XiPatternOneStepScenario_AAEX_PI_EOIO*), on the tab page *Objects* open the communication channel () *XiPatternChannel_FileSenderO* by double-clicking.
2. Under *File Access Parameter* in the *Source Directory* field, enter the path in the file directory that you defined previously (see [2.2.3](#)). In the case of the sender communication channel, enter the whole path for the file directory *XiPattern8*.
Example: C:/<selected path>/XiPatternsO_AAEX/XiPattern8
3. Save the communication channel.
4. Following the same procedure, edit the communication channel *XiPatternChannel_XiReceiver* (communication component <SID>_PI_BusComponent_XiPattern9).
5. Enter the URL to the Integration Server as Target URL (for example http(s)://<PI Dual Stack-host>:<PI Dual Stack-port>/sap/xi/engine?type=entry). As *User Name*, set PIAPPLUSER (or a copy of the PIAPPLUSER) with the respective *User Password* in the Integration Server Client, in field *Logon Client* set the client of the integration server (e.g. 001).
6. Save the communication channel.

Activating the Change List

1. To do this, select the *Change Lists* tab page in the Integration Directory navigation area.
2. Choose *Open* → *Standard Change List*.
3. Position the cursor on the *Standard Change List* node and choose *Activate* () in the context menu.

4.2 Configuring the Process Integration Scenario in the PI Dual Stack System

4.2.1 Design Objects Used

You use the component view *File2File_NoMapping_InOrder* in process integration scenario *XiPatternOneStepScenario* to configure this variant. The following graphic shows the component view:

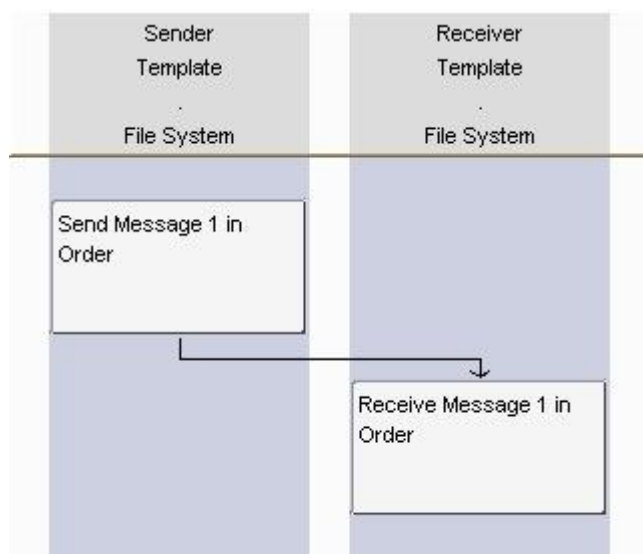

SAP NetWeaver Process Integration, Process Integration Scenario Editor

Interface Objects

In this variant, the data structures at both the sender and receiver side are the same and no mapping is required, the service interfaces *XiPatternInterface10* is used for sender and receiver

Summary of Design Objects Used

The following table summarizes the design objects used.

Design Objects Used

Object Type (Name)	Description
Component View <i>File2File_NoMapping_InOrder</i> (Process Integration Scenario <i>XiPatternOneStepScenario</i>)	Describes the process flow and the message exchange for this variant.
Service interface (<i>XiPatternInterface10</i>)	Describes the interface and data structure of the sender and receiver. The data structure is the same for sender and receiver.
Message Type (<i>XiPatternMessage1</i>)	
Data Type (<i>XiPatternDataType1</i>)	

4.2.2 Configuring the Process Integration Scenario in the PI Dual Stack System

To configure this variant, a new configuration scenario needs to be created in the PI Dual Stack System to enable message flow from the Advanced Adapter Engine Extended to the receiver adapter in the PI Dual Stack System.

Selecting the Process Integration Scenario

Perform the following steps to select the process integration scenario that you want to configure from the Enterprise Services Repository. Also, enter the name of the configuration scenario (in the Integration Directory) in which you want to group the configuration objects.

1. To call the model configurator, choose *Tools* → *Apply Model from ES Repository* in the Integration Builder menu bar.

This calls a wizard, which you use to select a model (in this case, a process integration scenario) and create a configuration scenario in the Integration Directory.

2. Make sure that the model type *Process Integration Scenario* is selected (checkbox under *Type of ES Repository Model*).

3. Choose the input help (for the *Name* field) () and select *Process Integration Scenario* in the dropdown listbox.

This calls an input help, which displays all process integration scenarios from the Enterprise Services Repository in a list.

4. Select the process integration scenario *XiPatternOneStepScenario* (software component version *SAP BASIS 7.31*, namespace <http://sap.com/xi/XI/System/Patterns>) from the Enterprise Services Repository and choose *Apply*.
5. Choose *Continue*.
6. Enter the name of the configuration scenario as:
`XiPatternOneStepScenario_AAEX_PI_EOIO`.
7. Choose *Finish* and then *Close*.

The system calls the model configurator.

Selecting the Component View



Select component view *File2File_NoMapping_InOrder*.

Assigning Communication Component

Assign the communication component `<SID>_AAEX_BusComponent_XiPattern8` to the application component *Sender* and `<SID>_PI_BusComponent_XiPattern9` to the application component *Receiver*.

Configuring the Connection

You create the communication channel on the basis of the communication channel templates that the process integration scenario already contains.

1. In the *Configure Connections* screen, assign the receiver a communication channel. To do so, place the cursor in the field *Communication Channel for the Receiver Component*, in the push button bar choose  → *Create Communication Channel With Template* (). In the subsequent wizard you can create a communication channel based on a communication channel template.
2. Choose *Continue*.

The default communication channel template on the subsequent screen is that which was assigned to the receiver application component in the process integration scenario (name *XiPatternChannel_FileReceiverO*, software component version *SAP BASIS 7.31*, namespace <http://sap.com/xi/XI/System/Patterns>).

3. Choose *Continue*.

The default name for the communication channel on the next screen is *XiPatternChannel_FileReceiverO*.

4. Confirm your selection by choosing *Finish*.

Generating the Configuration Objects

To do so, proceed as described in variant 1.

When you have checked the generation log, close it and save the configuration scenario.

Manual Editing

In the following steps, you edit the generated configuration objects manually and enhance the configuration settings made during generation. In this variant, you must edit the communication channels after generation.

1. In the editor *Display Configuration Scenario* (for the open scenario *XiPatternOneStepScenario_AAEX_PI_EOIO*), on the tab page *Objects* open the communication channel () *XiPatternChannel_FileReceiverO* by double-clicking.
2. Under *File Access Parameter* in the *Target Directory* field, enter the path in the file directory that you defined previously (see [2.2.3](#)). In the case of the receiver communication channel, enter the whole path for the file directory *XiPattern9*.
Example: C:/<selected path>/XiPatternsO_AAEX/XiPattern9
3. Save the communication channel.
4. Activate your change lists.

4.3 Execution

You perform the following steps to check that the process integration scenario is executed without errors.

1. Stop the channel <SID>_AAEX_BusComponent_XiPattern8 | *XiPatternChannel_FileSenderO* I in *Configuration and Monitoring Home* → *Adapter Engine* → *Communication Channel Monitoring* to make sure no processing runs during the time the files are placed into the source folder.
2. On the host of the PI Dual Stack System open the file directory *XiPatternsO_AAEX/XiPatterns9*. If the output file *XiPatternReceiverFile.txt* is already present, delete this file. The execution of this test will create this file if it is not present and append a series of output files to this file.
3. On the host of the Advanced Adapter Engine Extended open the file directory *XiPatternsO_AAEX/XiPatterns8*
4. Unpack file *XiPatternSenderFilesEOIO.zip* in the current directory. This will place a series of input files *XiPatternSenderFile00001.xml*, ..., *XiPatternSenderFile01000.xml*.

The File/FTP adapter is configured so that the files are picked in the order sorted by the file names and moved from the source directory *XiPatterns8* on the Advanced Adapter Engine Extended to the target directory *XiPatterns9* on the PI Dual Stack System and the files are concatenated into a single file *XiPatternReceiverFile.txt*.

5. Start the channel <SID>_AAEX_BusComponent_XiPattern8 | *XiPatternChannel_FileSenderO* in *Configuration and Monitoring Home* → *Adapter Engine* → *Communication Channel Monitoring* to start processing the files.
6. Open the directory *XiPatternsO_AAEX/XiPatterns9* and check that the files have been transferred.
7. Open the XML file *XiPatternReceiverFileAll.xml* which includes the output file and check whether the content is in the correct order.



The content must be in the correct order with the incremental ID value and the entire content must be present.

8. Furthermore, you can check the processing of the messages in the message monitoring on the Advanced Adapter Engine Extended and in the PI Dual Stack System as in Variant 1.