

SAP NetWeaver Guides



Monitoring Setup Guide for SAP NetWeaver 7.0 (2004s) SPS 12

May 2007



SAP AG
Neurottstraße 16
69190 Walldorf
Germany
T +49/18 05/34 34 24
F +49/18 05/34 34 20
www.sap.com

© Copyright 2007 SAP AG. All rights reserved.

No part of this publication may be reproduced or transmitted in any form or for any purpose without the express permission of SAP AG. The information contained herein may be changed without prior notice.

Some software products marketed by SAP AG and its distributors contain proprietary software components of other software vendors.

Microsoft®, WINDOWS®, NT®, EXCEL®, Word®, PowerPoint® and SQL Server® are registered trademarks of Microsoft Corporation.

IBM®, DB2®, DB2 Universal Database, OS/2®, Parallel Sysplex®, MVS/ESA, AIX®, S/390®, AS/400®, OS/390®, OS/400®, iSeries, pSeries, xSeries, zSeries, z/OS, AFP, Intelligent Miner, WebSphere®, Netfinity®, Tivoli®, Informix and Informix® Dynamic Server™ are trademarks of IBM Corp. in USA and/or other countries.

ORACLE® is a registered trademark of ORACLE Corporation.

UNIX®, X/Open®, OSF/1®, and Motif® are registered trademarks of the Open Group.

LINUX is a registered trademark of Linus Torvalds and others.

Citrix®, the Citrix logo, ICA®, Program Neighborhood®, MetaFrame®, WinFrame®, VideoFrame®, MultiWin® and other Citrix product names referenced herein are trademarks of Citrix Systems, Inc.

HTML, DHTML, XML, XHTML are trademarks or registered trademarks of W3C®, World Wide Web Consortium, Massachusetts Institute of Technology.

JAVA® is a registered trademark of Sun Microsystems, Inc.

J2EE™ is a registered trademark of Sun Microsystems, Inc.

JAVASCRIPT® is a registered trademark of Sun Microsystems, Inc., used under license for technology invented and implemented by Netscape.

MarketSet and Enterprise Buyer are jointly owned trademarks of SAP AG and Commerce One.

SAP, SAP Logo, R/2, R/3, mySAP, mySAP.com, xApps, mySAP Business Suite, and other SAP products and services mentioned herein as well as their respective logos are trademarks or registered trademarks of SAP AG in Germany and in several other countries all over the world. All other product and service names mentioned are the trademarks of their respective companies.

Disclaimer

Some components of this product are based on Java™. Any code change in these components may cause unpredictable and severe malfunctions and is therefore expressly prohibited, as is any decompilation of these components.

Any Java™ Source Code delivered with this product is only to be used by SAP's Support Services and may not be modified or altered in any way.

Documentation in the SAP Service Marketplace

You can find this documentation at the following Internet address:
service.sap.com/instguides

Typographic Conventions

Type Style	Represents
Example Text	Words or characters that appear on the screen. These include field names, screen titles, pushbuttons as well as menu names, paths and options.
Example text	Emphasized words or phrases in body text, titles of graphics and tables
EXAMPLE TEXT	Names of elements in the system. These include report names, program names, transaction codes, table names, and individual key words of a programming language, when surrounded by body text, for example, SELECT and INCLUDE.
Example text	Screen output. This includes file and directory names and their paths, messages, names of variables and parameters, source code as well as names of installation, upgrade and database tools.
Example text	Exact user entry. These are words or characters that you enter in the system exactly as they appear in the documentation.
<Example text>	Variable user entry. Pointed brackets indicate that you replace these words and characters with appropriate entries.
EXAMPLE TEXT	Keys on the keyboard, for example, function keys (such as F2) or the ENTER key.

Icons





Icon	Meaning
	Caution
	Example
	Note
	Recommendation
	Syntax

Table of Contents

1. USING THIS DOCUMENT	8
1.1. Required Files	8
2. INTRODUCTION	9
2.1. Motivation	9
2.2. Technology	9
2.2.1. Availability Monitoring	9
2.2.2. Monitoring Log Files	10
2.2.3. Distributed Statistics Records (DSR)	10
2.3. Components of Monitoring	11
2.3.1. Alert Monitor	11
2.3.2. Visual Administrator	11
2.3.3. System Landscape Directory	11
2.3.4. SAP NetWeaver Administrator	12
2.3.5. CCMS Agents	12
2.3.6. Operating System Collector SAPOSCOL	13
2.3.7. Standalone Log Viewer	13
2.3.8. Global Workload Monitor	13
3. OVERVIEW OF THE CONFIGURATION STEPS	15
4. CONFIGURATION STEPS IN DETAIL	18
4.1. Adjusting the Central Monitoring System (CEN)	18
4.1.1. Activating Background and Central System Dispatching	18
4.1.2. Creating the CSMREG User	18
4.1.3. Creating the CSMCONF Start File for CCMS Agents	19
4.1.4. Entering Monitored ABAP Systems in CEN	19
4.1.5. Entering Monitored ABAP Systems in ST03G	21
4.1.6. Creating RFC Destinations for Displaying Components in ST03G	22
4.1.7. Setting Up Availability Monitoring with CCMSPING	23
4.2. Monitoring ABAP Instances	23
4.2.1. Registering a CCMS Agent SAPCCM4X	24
4.3. Monitoring Java Instances	25
4.3.1. Registering a CCMS Agent SAPCCMSR (Java Standalone)	26
4.3.2. Registering a CCMS Agent SAPCCMSR (Double-Stack)	28
4.3.3. Displaying DSRs for the Java Instance in CEN	30
4.3.4. Configuring Availability Monitoring with the GRMG	32
4.4. Monitoring the Portal Infrastructure	33
4.4.1. Configuring Availability Monitoring with the GRMG	34
4.5. Monitoring TREX	36

4.5.1.	Registering SAPCCMSR	36
4.5.2.	Activating TREX Monitoring	37
4.5.3.	Displaying the DSRs for the TREX Instance in CEN	38
4.6.	Monitoring the Adobe Document Services	39
4.6.1.	Configuring Availability Monitoring with the GRMG	39
4.7.	Monitoring the Exchange Infrastructure	40
4.7.1.	Making Adjustments in CEN	40
4.7.2.	Configuring Availability Monitoring with the GRMG	41
4.8.	Monitoring a Standalone Database	43
4.8.1.	Installing SAPCCMSR and SAPOSCOL	43
4.8.2.	Configuring Process Monitoring for the Database	45
4.9.	Monitoring the SAP Business Information Warehouse	46
4.9.1.	Configuring Availability Monitoring with the GRMG	46
4.10.	Monitoring the SAP Mobile Infrastructure	48
5.	MONITORING SAP NETWEAVER 7.1 SYSTEMS	49
5.1.	Monitoring SAP NetWeaver Composition Environment (CE) 7.1	49
5.1.1.	Registering CCMS Agent SAPCCMSR	49
5.1.2.	Creating a Customizing Destination	50
5.1.3.	Display the DSRs from the CE System in CEN	52
5.1.4.	Configuring Availability Monitoring with GRMG	52
5.1.5.	Activating Availability Monitoring for a CE System	53
5.2.	Monitoring ABAP Systems with Release SAP NetWeaver 7.1	54
6.	CONFIGURATION STEPS FOR SAP NETWEAVER ADMINISTRATOR	55
6.1.	Overview	55
6.2.	Prerequisites	56
6.3.	Setting Up Using the Template Installer	56
6.3.1.	Configure and Activate the Administrative SLD	58
6.3.2.	Make Connection Settings Between CEN and SLD	59
6.3.3.	Basic Configuration of the NWA	59
6.3.4.	Configure the Connections Between the ABAP and Java Stacks of CEN	60
6.3.5.	Configure the Connections from the NWA to the Administered Java Systems	61
6.3.6.	Connect a Monitored ABAP System to the Administrative SLD	61
6.3.7.	Connect a Monitored Java System to the Administrative SLD	62
6.4.	Setting Up the Administrative SLD	63
6.4.1.	Making Settings in the SLD	64
6.4.2.	Making Settings in the Monitored Systems	65
6.5.	Manual Setup of the NWA	67
6.5.1.	Configuring User Administration	67

6.5.2.	Configuring the Connection Between CEN and the SLD	68
6.5.3.	Configuring a Connection Between the ABAP and Java Stacks of CEN	70
6.5.4.	Storing Access Data for the Java Systems to Be Administered	71
6.6.	Monitoring SAP NetWeaver Composition Environment (CE) 7.1 with NWA	72
6.6.1.	Connecting the CE System to the Administrative SLD	72
6.6.2.	Creating the Required Associations for the CE System in the SLD	73
6.6.3.	Configuring the Connections from the NWA to CE Systems	73
6.7.	Problem Analysis Scenario for the Setup of the NWA	74
7.	MOVING A CENTRAL MONITORING SYSTEM	78
7.1.	Preparatory Steps in CEN2	79
7.1.1.	Release and Patch of the New Central Monitoring System CEN2	79
7.1.2.	Create Dispatching and CSMREG in CEN2	79
7.2.	Steps for Moving the NWA	79
7.2.1.	Initial Configuration of and Data Provision for the New Administrative SLD	79
7.2.2.	Configuring the NWA	80
7.3.	Deregistering/Registering CCMS Agents	80
7.4.	Availability Monitoring (CCMSPING/GRMG)	81
7.4.1.	Deregister/Register CCMSPING	81
7.4.2.	Other Settings for Availability Monitoring with CCMSPING	81
7.4.3.	Availability Monitoring with GRMG/GRMGLite	82
7.5.	Settings for Monitored Systems	83
7.5.1.	Entering Monitored ABAP Systems	83
7.5.2.	System Groups	83
7.5.3.	Central Display of Statistics Data with Transaction ST03G	83
7.6.	Checking the Dataset of the Administrative SLD	84
7.7.	Central Performance History	84
7.8.	Properties and Methods	84
7.8.1.	Method Definitions and Releases	84
7.8.2.	Properties and Method Assignments	86
7.8.3.	Central Auto-Reactions	86
7.9.	Monitor Definitions and Monitor Sets	87
7.10.	Other Points	87
7.10.1.	Monitoring Infrastructure Alerts	87
7.10.2.	Special Monitoring Tasks	87
8.	ADDITIONAL INFORMATION	89
8.1.	Known Problems	89

8.1.1.	Error when Generating the CSMCONF Start File	89
8.1.2.	Agent registration not possible with Visual Administrator	89
8.1.3.	Tab Page <i>CCMS Agent Configuration</i> in VA is missing	89
8.1.4.	Agent registration fails due to wrong password	89
8.2.	SAP Service Marketplace	89
8.3.	Useful SAP Notes	90

1. Using This Document

This document describes how you can quickly and easily perform the configuration for the monitoring of a system landscape based on SAP NetWeaver 7.0 SP Stack 12. It is a prerequisite that you have already completed the actual installation of the relevant components.

The individual sections of the document have the following contents:

- **Section 1** contains an overview of the different sections and a list of the files that you require to perform the configuration steps, broken down by component.
- **Section 2** contains a short introduction to the concepts and the monitoring tools used.
- **Section 3** contains an overview of which configuration steps need to be performed for which component. This section is fully linked with section 4, which explains the configuration steps in detail.
- **Section 4** contains the step-by-step instructions for these configuration steps, together with the respective prerequisites and the optional steps with which you can check whether you have successfully performed the configuration.
- **Section 5** contains the step-by-step instructions for these configuration steps, which are necessary to monitor systems of release SAP NetWeaver 7.1 with a central monitoring system (CEN) with a release of SAP NetWeaver 7.0.
- **Section 6** contains step-by-step instructions for the additional configuration steps for using the SAP NetWeaver Administrator.
- **Section 7** contains step-by-step instructions for moving the central monitoring system (CEN) from one system to another. This section is **not** part of an initial setup; it is therefore only part of this document because the initial steps are also performed during the moving of CEN.
- **Section 8** contains links to additional information.

1.1. Required Files

To configure monitoring, and depending on the components, you may require certain additional files that are not yet available after installing the relevant components. You can find these in the following locations:

Component	File	Available in
Exchange Infrastructure	SAP_XI30_GRMG_Cust_Template.txt	SAP Note 634771
Standalone Database	CCMAGENT.SAR SAPOSCOL.SAR	SAP Service Marketplace
	INSTALL_UX.SAR INSTALL_WIN.SAR	SAP Note 704349

2. Introduction

2.1. Motivation

Monitoring a system landscape is a complex task of significant importance for every company that operates one or more SAP systems. The complexity increases with every additional system, component, or extension.

With the monitoring architecture of the CCMS (Computing Center Management System), SAP provides a flexible and universally-usable infrastructure with which you can monitor your entire IT landscape centrally, and which reports problems quickly and reliably.

The monitoring architecture is delivered free-of-charge with every SAP NetWeaver Application Server. The architecture runs on every SAP NetWeaver Application Server and can be easily extended to include additional SAP and non-SAP components.

The concept of the monitoring architecture is to make all required information available in a central monitoring system (CEN), and therefore to make the administrators' work easier. Problems are displayed as soon as they occur; the log files can also be accessed from one location, which reduces the time required for error identification and correction. In this way, the monitoring architecture allows you to achieve greater efficiency with lower costs.

Additional configuration steps allow advanced technologies, such as notifications, meaning that administrators no longer have to actively check the systems for alerts.

These instructions combine the configuration steps required for monitoring a system landscape based on SAP NetWeaver 7.0 SP Stack 12. SAP Support can only provide optimal support for landscapes for which these configuration steps have been performed.

2.2. Technology

2.2.1. Availability Monitoring

It is not possible to uniquely define availability with regard to IT components. In this way, "availability" can mean the existence of a process at operating system level. Other definitions of availability could include, for example, the provision of a service within a certain time or the average time for performing a user action between 08:00 and 18:00.

SAP provides different mechanisms for availability monitoring. The mechanisms have the following in common:

- The availability information is usually technical.
- The availability check is performed – once it has been set up – periodically and without user interaction.
- The result of the check is reported in the central CCMS and therefore also in the Solution Manager. This means that an availability monitor can be set up centrally that displays the status of the individual components. It is also possible to implement automatism and notifications using auto-reactions.
- Availability is checked at application-level with the Generic Request and Message Generator (GRMG).

With the GRMG, the central system periodically calls a GRMG application using a URL. The GRMG application performs component-specific checks and returns the result of the checks to the central system.

If a GRMG check is not possible or not meaningful for a component, it is possible at least to prove the existence of the corresponding process at operating system level. A check of this type provides defines the required (but not sufficient) prerequisite for the component availability. The check is performed by the SAP program SAPOSCOL and the SAPCCMSR agent.

For more detailed information about the GRMG, see [GRMG].

2.2.2. Monitoring Log Files

JAVA-based applications write messages to log files. In complex applications, important messages can be distributed across significantly more than 100 log files. To ensure stable operation, To ensure stable operation, these log files should be regularly checked for error messages.

SAP provides a mechanism for automatically analyzing log files. With this mechanism, the CCMS agent SAPCCMSR checks the log files every minute for predefined search patterns. If the agent find the pattern, it reports an alert in the central monitoring system. The administrator can be informed from there on the basis of the alert.

As an administrator, you can see all checked log files in the alert monitor (transaction RZ20) of the central monitoring system. If an error occurs, you can expand the corresponding subtree in the *Logfile Monitoring* monitor, and find the name and path of the log file in which an error was logged from the *Complete Name* node.

Advantages of central log file monitoring and alerting:

- Regular checks of the large number of log files are performed automatically.
- The administrator can be automatically notified if problems occur.
- The standalone log viewer provides you central access to all log files in your NetWeaver landscape (even if the corresponding J2EE Engine is no longer running).
- The standalone log viewer can also display ASCII-based logs for other applications, such as the database.

2.2.3. Distributed Statistics Records (DSR)

Statistics records are generated so that you can monitor the performance of an ABAP system and its components. You can use these statistics records to determine what workload is generated and which resources are used when an action is performed in the system. This means that you obtain

- An exact picture of the general performance of a system
- If problems occur, information about their cause

Distributed Statistics Records (DSRs) extend this concept to non-ABAP components, such as the J2EE Engine.



No separate configuration steps are required for the writing of DSRs, you only need to activate the display of the corresponding component in the Global Workload Monitor of CEN.

For general information about DSRs, see the SAP NetWeaver Library under *SAP NetWeaver* → *Application Platform* → *Java Technology in SAP Web Application Server* → *Administration Manual* → *Server Administration* → *Monitoring* → *Statistics* → *Distributed Statistics Records (DSRs)*.

2.3. Components of Monitoring

2.3.1. Alert Monitor

The alert monitor is the central tool with which you can efficiently administer and monitor distributed SAP solutions or client-server systems. The alert monitor displays problems quickly and reliably. The alert monitor has, among other things, the following properties:

- You can use the alert monitor to monitor all SAP and non-SAP systems, the host systems and the database completely and in detail.
- All errors generate alerts that are displayed in a tree structure; the most significant error is reported upward in the display hierarchy.
- You can assign analysis and auto-reaction methods to the individual nodes. These methods contribute to quicker processing of the error.
- You can adjust all settings individually and configure your own monitors.

For general information about the alert monitor, see the SAP NetWeaver Library under *SAP NetWeaver* → *Solution Life Cycle Management* → *Solution Monitoring* → *Monitoring in CCMS* → *Alert Monitor*.

2.3.2. Visual Administrator

The J2EE Engine Visual Administrator is a graphical user interface for administering entire clusters, all cluster elements, and all modules that are running on the J2EE Engine. Among other things, it includes the following functions in a single user interface:

- Obtaining general information about a service, a manager, and interface, or a library
- Administration and changing of the properties for services and managers
- Configuration of global properties
- Administration and monitoring at runtime
- Performing deployments of applications

2.3.3. System Landscape Directory

The SAP System Landscape Directory (SLD) is the central information provider in a system landscape. The SLD contains two types of information:

- **Component information:** all available SAP products and components and their versions. If appropriate, external products are also registered here.
- **Landscape description:** all installed systems in a system landscape.

2.3.4. SAP NetWeaver Administrator

The SAP NetWeaver Administrator (NWA) unifies the most important administration and monitoring tools both for Java and for ABAP systems in a new, browser-based user interface. The most important advantages of the NWA are:

- You no longer need to switch between different tools for administration, troubleshooting, and problem analysis of your entire SAP NetWeaver system landscape.
- There is now a central administration tool available to you landscape-wide for both Java and ABAP systems for starting and stopping instances, checking configuration settings and logs, and monitoring error-free functioning of components.
- The interface follows the current guidelines for interface design, is easy-to-use, task-oriented, and complete. By using Web Dynpro, it runs in a normal browser.
- The interface allows seamless navigation to other SAP NetWeaver administration tools (User Management Engine, in the future also System Landscape Directory, Adaptive Computing).
- For Java, the NWA represents the crossover from various expert tools to an integrated, simple, and clear solution. The NWA also completes the integration of the data sources for monitoring.
- For ABAP, the NWA represents the crossover from many different expert transactions, some of which are difficult to use, to integrated, centrally available information.

The NWA is delivered for the first time for SAP NetWeaver 04 SP Stack 12. A more advanced version is delivered with SAP NetWeaver 7.0. It is intended to deliver an advanced version with SAP NetWeaver 7.1. The NWA will also be continually further developed in later releases, and extended with additional administration and monitoring functions.

2.3.5. CCMS Agents

CCMS agents are independent processes with an interface using RFC to a central monitoring system and an interface to the shared memory. These agents have the following properties:

- A connection to CEN using RFC, to ensure greater downtime security and general availability
- Use of the push technology to optimize performance when reading and writing monitoring attributes and alerts
- Inclusion of the operating system collector SAPOSCOL to monitor processes at operating system level.
- Connection to systems with no SAP NetWeaver Application Server

- Monitoring of any log files

There are various CCMS agents, including:

Agent	Task
SAPCCMSR	Monitoring of components on which no SAP ABAP instance is active, such as the J2EE Engine or SAP IPC
SAPCCM4X	Monitoring of SAP ABAP systems as of SAP Basis 4.X

For detailed information about CCMS agents, see **[Agents]**.

2.3.6. Operating System Collector SAPOSCOL

The operating system collector SAPOSCOL is an independent program that runs in the operating system background. It functions independently of the SAP instances, exactly once per monitored host. SAPOSCOL collects data about operating system resources, including:

- Usage of virtual and physical memory
- CPU utilization
- Utilization of physical hard disks and file systems
- Resource usage of running processes

For more detailed information about SAPOSCOL, see **[SAPOSCOL]**.

2.3.7. Standalone Log Viewer

With the standalone log viewer, you can monitor any J2EE Engine or Java application log files, even if the J2EE Engine is not functioning correctly, cannot be started, or is not available on the system to be monitored. The standalone log viewer contains any number of servers and one client:

- The server of the standalone log viewer monitors log files that are registered with this server. It must be installed on every host of the J2EE system landscape. The various servers function independently of each other.
- The client of the standalone log viewer connects to one or more servers of the standalone log viewer and displays the contents of the log files. You only need to install the client once in the J2EE system landscape.

For general information about the standalone log viewer, see the SAP NetWeaver Library under *SAP NetWeaver → SAP NetWeaver by Key Capability → Application Platform by Key Capability → Java Technology in SAP Web Application Server → Administration Manual → Supportability and Performance Management → Logging → Log Viewer → Standalone Log Viewer*.

2.3.8. Global Workload Monitor

The Global Workload Monitor (transaction ST03G) displays statistical records for entire landscapes and therefore allows the analysis of statistical data from ABAP and non-ABAP systems. You can use this data to analyze the workload of the monitored components in great detail.

While statistics records for an ABAP system can only trace actions that are processed by ABAP components, you can use Distributed Statistics Records (DSRs) to trace actions that are processed by, for example, the J2EE Engine, ITS, and TREX. You can even do so across component boundaries.

3. Overview of the Configuration Steps

This section lists the configuration steps required for the different SAP NetWeaver components. Together with the detailed description of the installation steps in section [0](#), the tables provide a template for the configuration of your IT landscape.

Print this section and perform the specified steps for each component. A link is provided below to a step-by-step description for the areas in which manual steps are required.

First perform the following steps **in any case**:

In CEN:

- [Adjusting the Central Monitoring System \(CEN\) \[page 18\]](#)

For every instance of a J2EE Engine:

- [Registering a CCMS Agent SAPCCMSR \[page 26\]](#)
- [Configuring Availability Monitoring with the GRMG \[page 32\]](#)

For every ABAP instance:

- [Registering a CCMS Agent SAPCCM4X \[page 24\]](#)

If you want to use the SAP NetWeaver Administrator, perform the following steps landscape-wide:

- [Setting Up Using the Template Installer \[page 56\]](#)
- [Setting Up the Administrative SLD \[page 63\]](#)

Now perform the appropriate configuration steps from the table below, depending on the components in use in your system landscape. The table contains a corresponding link for each area in which manual steps are required, as well as an empty column (✓), which you can use for marking off the steps that you have already performed.



A special case occurs, if you want to monitor components based on SAP NetWeaver 7.1 centrally. Until the general shipment of SAP NetWeaver 7.1, still use a central monitoring system with release SAP NetWeaver 7.0 (see [Monitoring SAP NetWeaver 7.1 Systems \[page 49\]](#)).

	✓ PI	✓ TREX	✓ Adobe Document Services
Adjustments in CEN	-	-	-
SAPCCMSR/ SAPOSCOL	-	Registering SAPCCMSR [page 36]	-
GRMG	Configuring Availability Monitoring with the GRMG [page 34]	Activating TREX Monitoring [page 37]	Configuring Availability Monitoring with the GRMG [page 39]
Process Monitoring	-	Activating TREX Monitoring [page 37]	-
Logfile Monitoring	-	Activating TREX Monitoring [page 37]	-

	✓ Exchange Infrastructure	✓ Standalone Database	✓ BI
Adjustments in CEN	Making Adjustments in CEN [page 40]	-	-
SAPCCMSR/ SAPOSCOL	-	Registering SAPCCMSR [page 43]	-
GRMG	Configuring Availability Monitoring with the GRMG [page 41]	-	Configuring Availability Monitoring with the GRMG [page 46]
Process Monitoring	-	Configuring Process Monitoring for the Database [page 45]	-
Logfile Monitoring	-	-	-

	✓	Mobile Infrastructure
Adjustments in CEN		Monitoring the SAP Mobile Infrastructure [page 48]
SAPCCMSR/ SAPOSCOL		-
GRMG		Monitoring the SAP Mobile Infrastructure [page 48]
Process Monitoring		-
Logfile Monitoring		-

4. Configuration Steps in Detail

4.1. Adjusting the Central Monitoring System (CEN)

Prerequisites:

- CEN has the NW 7.0 release and Support Package level discussed in this document.
- You have a user with administrator authorization in CEN.

4.1.1. Activating Background and Central System Dispatching

For all data collection methods in the monitoring architecture to be correctly started, background dispatching needs to be activated. It starts all data collection methods that are executed periodically in the background process (as jobs).

To execute an auto-reaction in CEN for alerts from remote systems, central system dispatching needs to be activated.



Activate background dispatching in CEN and in all monitored ABAP systems in client 000.

Step-by-Step

1. Call transaction RZ21. The *Monitoring: Properties and Methods* screen appears.
2. Choose *Technical Infrastructure* → *Local Method Execution* → *Activate Background Dispatching*.



Background dispatching is performed by the job `SAP_CCMS_MONI_BATCH_DP`, which runs once an hour. Note that not only this job, but also the data collection methods started by this job, run under your user name. You should therefore ensure that your user has the authorizations required for this.

Activate central system dispatching in CEN:

Step-by-Step

3. Call transaction RZ21. The *Monitoring: Properties and Methods* screen appears.
4. Choose *Technical Infrastructure* → *Configure Central System* → *Activate Central System Dispatching*.



Central system dispatching is performed by the job `SAP_CCMS_CENSYSDISPATCHER`.

4.1.2. Creating the CSMREG User

You require a user with specific, greatly restricted authorizations for communication between monitored systems and CEN.



You must create this user in CEN and all monitored ABAP systems yourself.



You need to use a backward-compatible password, if you are monitoring systems with a release of SAP Web AS 6.20 or lower. A password is backward-compatible if it does not contain any lower-case letters and is a maximum of 8 characters long (see also SAP Note 807895 and [Agent registration fails due to wrong password \[page 89\]](#)).

Step-by-Step

5. Call transaction RZ21 in the relevant systems.
6. Choose *Technical Infrastructure* → *Configure Central System* → *Create CSMREG User*.
7. Specify any password for this user. You require it during the installation and registration of the CCMS agents and when creating RFC destinations in monitored systems, among other things.

4.1.3. Creating the CSMCONF Start File for CCMS Agents

During the registration of CCMS agents, you specify information about the CEN and about the users used for communication between the agent and CEN. Create a CSMCONF start file in CEN; you will require this file later, during the registration of the CCMS agents. In this case, the current user is used as the required user with administration authorization.

Step-by-Step

1. In CEN, call transaction RZ21.
2. Choose *Technical Infrastructure* → *Configure Central System* → *Create CSMCONF Start File for Agents*.
3. Define the storage location. When doing so, ensure that you will be able to access this file when setting up the various components.



If an error message appears when saving the file, this can be due to the fact that you do not have the current version of SPA GUI. In this case, save the CSMCONF file as a text file and then delete the `.txt` file extension.

4. You should keep a CEN window open for the rest of the setup process, so that you can easily check that the other steps have been successful.

4.1.4. Entering Monitored ABAP Systems in CEN



To monitor remote ABAP systems in CEN, create a corresponding entry in the alert monitor. To do this, first set up two RFC destinations for the monitored system in CEN; these RFC destinations each serve one of the following purposes:

- Data collection (transferring monitoring data to CEN)
- Analysis (calling analysis methods in the monitored system from CEN)

Step-by-Step

1. Call transaction RZ21 in CEN.
2. Choose *Technical Infrastructure* → *Configure Central System* → *Create Entry for Remote System*.
3. The *Monitoring: Create New Entry* screen appears. Choose *Goto* → *RFC Connections*.
4. If no suitable RFC destination exists for the system that you want to monitor, choose *Create*.
5. Make the following specifications on the definition screen:
 - *RFC Destination*: Enter a name for the RFC destination; we recommend the following naming convention:
<SID of the monitored system>_RZ20_COLLECT or
<SID of the monitored system>_RZ20_ANALYZE
 - *Connection Type*: Enter 3.
 - *Description*: Enter a description for the RFC destination.
Choose the *Logon/Security* tab page, and, depending on the RFC destination to be created, enter the data for the appropriate user in the *Logon* group box:
 - *RFC Destination for Data Collection* <SID>_RZ20_COLLECT: Enter the CSMREG user that you created in the relevant system in accordance with [Creating the CSMREG User \[page 18\]](#).
 - *RFC Destination for the Execution of the Analysis Method* <SID>_RZ20_ANALYZE: Either choose the *Current User* option, or enter any user of your choice (in both cases, the user must have authorization for the alert monitor and for system administration in the target system).
6. Choose the *Technical Settings* tab page, and make the required entries. We recommend that you choose the option *Yes* for load distribution, and select the radio button *Hostname* for *Save to database as*.
7. Save your entries and set up the second RFC destination in the same way.
8. To return to the *Monitoring: Create New Entry* screen, choose the  *Back* button.
9. Create the entry for monitoring a remote ABAP system here. Make the following entries when doing so:
 - *Target System ID*: System ID of the monitored system
 - *RFC Destination of the Target System for Data Collection* and *RFC Destination of the Target System for Executing Analysis Methods* are the names of the RFC connections to the monitored system that you have just created.
10. Save your entries, and enter all other ABAP systems to be monitored in the same way.

Checking the Entries (Optional)

11. To check the entries for the monitored systems, call transaction RZ21, select the radio button *System Overview* in the *Topology* group box, and choose the button  *Display Overview*.
12. The system displays a list of the monitored systems. To test the connection, select the desired row and choose the  *Test Single Connection* button.

4.1.5. Entering Monitored ABAP Systems in ST03G



If you want to monitor the statistical data for the monitored ABAP systems in CEN, use the Global Workload monitor to do so, and enter an RFC destination for the monitored system in this transaction.

Prerequisites

For you to be able to display statistics data of a remote ABAP system in CEN, the job *SAP_COLLECTOR_FOR_PERFMONITOR* must be scheduled in the corresponding monitored ABAP system. To schedule the job, proceed as follows:

13. Start transaction SM36 in the monitored ABAP system.
14. Choose *Standard Jobs*.
15. In the *SAP Component* input field, select the *BC Basis* using the possible entries help.
16. In the *Job Name* input field, select the entry *SAP_COLLECTOR_FOR_PERFMONITOR* using the possible entries help.
17. For the *Start Time*, choose the radio button *Immed.*, and for the *Period*, select the *Hourly* radio button.
18. Save your settings.

Step-by-Step



1. In CEN, call transaction ST03G.
2. In the navigation bar, expand the subtree  *Settings & Log*, and double-click the  *System Selection* entry.
3. To also view the desired ABAP system in the list of the monitored components, first display a system list by choosing the button *Systems* → *<desired list>*.
4. Add an additional row to the list by choosing the  button (*Append Row*). Enter the following data in this row:

Column	Entry
<i>Activated</i>	Check the checkbox (together with the other components that you want to monitor)
<i>Component</i>	Name under which the monitored system is displayed; enter <SysID> or <SYSID> on <Host>
<i>Comp. Type</i>	SAP R/3
<i>Mon. Sys.</i>	System ID of CEN

Column	Entry
<i>Mon. Sys. Dest.</i>	RFC destination of the monitored system; if a suitable destination does not yet exist, create it using transaction SM59 (see also Creating RFC Destinations for Displaying Components in ST03G [page 22])

5. Choose the *Apply* button.
6. To save this list of monitored components in one of the five predefined storage locations, choose the button  (*Save*) → *<desired list>*, and specify a name there.

Checking the Entries (Optional)

7. To view the statistical data for one of the activated components, expand the path  *Workload* →  *<component name>* in the navigation bar.

4.1.6. Creating RFC Destinations for Displaying Components in ST03G

To be able to display statistics data for remote ABAP or double-stack systems with the Global Workload Monitor in a CEN, you need to create the required RFC destinations yourself. The ABAP or DSR statistics data is read from the remote system using this destination.

After you have created the RFC destinations in transaction SM59, you still need to inform the Global Workload Monitor of the RFC destination and activate the monitored component. For a description of the steps required to do this, see the following sections:

- [Entering Monitored ABAP Systems in ST03G \[page 21\]](#)
- [Displaying DSRs for the Java Instance in CEN \[page 30\]](#)

This section contains information about creating the required RFC destination.

Prerequisites

You can enter a user name and password when creating the RFC destination to the monitored system. You have the following options when doing so:

- If you do not specify a user and especially a password when creating the RFC destination, you need to explicitly log on to the relevant system again before displaying the statistical data in transaction ST03G.
- If you specify a user and password when creating the RFC destination (or there is a trusted system relationship between the systems), you can display the statistical data for this system from transaction ST03G without explicitly logging on to the monitored system. To avoid a security gap arising from this, this user should only have authorization to read statistics data in the remote system (if security is not ensured in another way). To do this, the user requires a profile that contains the following authorizations:

Component type	Authorization Object	Field	Value
ABAP System	S_RFC	RFC_FUGR	FUGR

		RFC_NAME	SCSM_NW_WORKLOAD SWNC_GLOB_SYSTEM SCSM_GLOB_STAT SAPWL_GLOB_STAT
		ACTVT	16
DSR component	S_RFC	RFC_FUGR	FUGR
		RFC_NAME	SAPWLN3_COLLECTOR SAPWLN3_UTILITIES
		ACTVT	16



Depending on the release status of the monitored system, it is possible that not all of the specified function groups exist in this system.

Activities

To create the RFC destination, start transaction SM59 in CEN and create an RFC destination of type 3 with any name.

On the *Logon/Security* tab page, specify a user under whose name the logon to the remote system is performed, and save the RFC destination.

4.1.7. Setting Up Availability Monitoring with CCMSPING

You can use the CCMSPING availability agent to check whether remote systems and their instances are available for work. It also collects important performance attributes for the dialog system on ABAP instances.



For a detailed description of availability monitoring, see the document *Availability Monitoring and Agent CCMSPING*. The document is available in the SAP Service Marketplace, in the *Monitoring* area (<http://service.sap.com/monitoring>) → *Monitoring in Detail*. Choose the *Availability Monitoring and Agent CCMSPING* document from the list ([direct link](#)).

Back to the  [Overview](#)

4.2. Monitoring ABAP Instances

Prerequisites:

- The monitored system has the NW 7.0 release and Support Package level discussed in this document.
- You have a user at operating system level on the ABAP instance host (<SID>adm).
- You have an administration user for the system.

- You have performed the preparatory steps in CEN, as described in [Adjusting the Central Monitoring System \(CEN\) \[page 18\]](#).

4.2.1. Registering a CCMS Agent SAPCCM4X

To monitor an ABAP instance of an SAP system, use the CCMS agent SAPCCM4X. This agent creates an alternative connection route between the monitored instance and the central monitoring system (CEN). Since this alternative connection method no longer requires a free work process, the access route is independent of error states of the ABAP instance and is therefore more robust.

You have to register the agent SAPCCM4X for every ABAP instance of the monitored system.



We recommend that you always use as current as possible a version of your CCMS agent SAPCCM4X. You can check the version using the command `sapccms4x -v`. Check SAP Notes 809007, 914721, and 1013331 for information about changes to agents, and download a new agent if these changes are relevant to you and your agent does not yet provide the applicable improvements.

For more information about downloading agents, see the SAP Help Portal under *SAP NetWeaver* → *SAP NetWeaver by KeyCapability* → *Solution Life Cycle Management by Key Capability* → *Solution Monitoring* → *Monitoring in the CCMS* → *CCMS Agents* → *Installing/Registering the CCMS Agents for Experts* → *Downloading CCMS Agents*, or follow the link below:

http://help.sap.com/saphelp_nw2004s/helpdata/en/ca/118110ff542640b7c86b570cc61ae3/frameset.htm.

Step-by-Step

1. Log on to the host of the ABAP instance as `<SID>adm` (UNIX) or `SAPService<SID>` (Microsoft Windows), to ensure that the agent can access the shared memory.
2. Copy the CSMCONF start file to the working directory of SAPCCM4X. This is in the following location:
MS Windows: `[drive]:\usr\sap\<SysID>\<inst.dir.>\log\sapccm4x`
UNIX: `/usr/sap/<SysID>/<inst.dir.>/log/sapccm4x`
If the directory does not exist, create it.
3. The executable SAPCCM4X is located in the following directory:
MS Windows: `[drive]:\usr\sap\<SysID>\SYS\exe\run`
UNIX: `/usr/sap/<SysID>/SYS/exe/run`
4. In the directory of the executable, enter the command `sapccm4x -R pf=<profile path>`.



<Profile path> specifies the start profile of the monitored instance. By default, this is:

MS Windows: [drive]:\usr\sap\\SYS\profile\
<SysID>_<Name instance directory>_<Host>

UNIX: /usr/sap/<SysID>/SYS/profile/
<SysID>_<Name instance directory>_<Host>

5. During the registration, the system displays specifications from the CSMCONF file to you again for confirmation. Confirm the specification by pressing the ENTER key in each case. You only need to enter two parameters yourself:
 - o The password for the administration user in CEN, under which you created the CSMCONF file
 - o The password for the CSMREG user
6. Under UNIX, you must ensure yourself that SAPCCM4X is automatically started again when the host is restarted. To do this, enter the following command in the inittab (/etc/inittab):

```
/usr/sap/<SysID>/SYS/exe/run/sapccm4x -DCCMS pf=<profile path>
```

Checking the Agent Registration (Optional)

7. To check whether the agent was successfully registered with CEN, call transaction RZ21 in CEN, select the radio button *Agents for Remote Systems*, and choose the  *Display Overview* button. The agent that you have just registered appears in the list in the row SAPCCM4X.<host name>.<inst. no.>.

4.3. Monitoring Java Instances

Prerequisites:

- The J2EE Engine has the NW 7.0 release and Support Package level discussed in this document.
- You have a user at operating system level on the J2EE Engine host (<SID>adm).
- You have an administration user for the J2EE Engine.
- You have performed the preparatory steps in CEN, as described in [Adjusting the Central Monitoring System \(CEN\) \[page 18\]](#).



If you're facing problems with registering the agent, consider SAP note 817714 (see [Agent registration not possible with Visual Administrator \[page 89\]](#)) and 929635 (see [Tab Page CCMS Agent Configuration in VA is missing \[page 89\]](#)).

4.3.1. Registering a CCMS Agent SAPCCMSR (Java Standalone)



If you want to register the agent with a J2EE Engine of a double-stack system, follow the procedure described in [Registering a CCMS Agent SAPCCMSR \(Double-Stack\) \[page 28\]](#).

The monitoring data for the J2EE Engine is transferred to central monitoring system (CEN) using the CCMS agent SAPCCMSR. The agent is part of the installation package of the Engine. You only need to register the agent **once for each Java** system with CEN and to start the agent.

Step-by-Step

1. Log on to the host of a J2EE Engine of the system as `<SID>adm`.
2. Copy the start file CSMCONF (see [Creating the CSMCONF Start File for CCMS \[page 19\]](#)) in the following directory:

Windows: `[drive]:\usr\sap\ccms\<SysID>_<Inst. No.>\sapccmsr`

UNIX: `/usr/sap/ccms/<SysID>_<Inst. No.>/sapccmsr`



You can also save the start file to any directory that you can access from your local host. In this case, however, you need to specify, during the registration of the agent, where you saved the file. To do this, choose the *Change ...* button in the *Monitoring* service of the Visual Administrator (see below), and specify the path of the start file. The file is then automatically copied to the above directory.

3. On the J2EE Engine's host, switch to the following directory:

Windows: `<J2EE home directory>\JC<Inst. No.>\j2ee\admin\`

UNIX: `<J2EE home directory>/JC<Inst. No.>/j2ee/admin/`



If you have installed the J2EE Engine together with an ABAP Engine, the letter combination in the name of the directory `JC<Inst. No.>` may vary.

4. Start the Visual Administrator by calling the start script `go` (UNIX) or `go.bat` (Microsoft Windows), and log on with your user as the J2EE Engine administrator.
5. In the navigation bar, choose *Cluster* → `<SysID>` → *Dispatcher* → *Services* → *Monitoring*, and choose the *CCMS Agent Configuration* tab page.
6. If you want to monitor multiple systems with the same system ID, select the *Long SID* indicator, and enter an identifier for the system in this input field that is unique within your system landscape. This “long system ID” must fulfill the following conditions:
 - The first three characters must be the system ID.
 - The name can consist of a maximum of eight characters.

- The name must not contain an underscore (_).
- 7. The access data for both users required in CEN is determined from the start file and displayed in the corresponding fields. If necessary, you can change the names of the users or the client.
- 8. Enter the passwords of the *CEN Administration User* and the *CEN CSMREG User* in the *Password* column. The *CEN Administration User* is the user with administrator authorization with which you created the CSMCONF start file; the *CEN CSMREG User* is the user in CEN that you created under [Creating the CSMREG User \[page 18\]](#).



If necessary, you can use the *Information* button to answer the following questions:

- Is the instance profile of the instance to be monitored valid?
 - Is the CSMCONF start file to be used valid?
 - What is the version of the CCMS agent SAPCCMSR?
9. Choose the *Register* button. The system displays the registration log; errors are highlighted in red.
10. Under UNIX, the agent is automatically started by the **startsap** script when you start the J2EE Engine. Under Microsoft Windows, you need to start the associated service (which was created during the installation of the J2EE Engine) yourself. To do this, on the Microsoft Windows host on which the agent is running, choose *Start* → *Settings* → *Control Panel* → *Administrative Tools* → *Services*, and choose the service *SAPCCMSR.<Instance No.>* by double-clicking it. Set the *Start Type* to *Automatic*, and choose *Start*.

Checking the Agent Registration (Optional)

11. To check whether the agent was successfully registered with CEN, call transaction RZ21 in CEN, select the radio button *Agents for Remote Systems*, and choose the  *Display Overview* button. The agent that you have just registered appears in the list in the row *SAPCCMSR.<host name>.<inst. no.>*.
12. To check whether the J2EE Engine has been included in the system group *J2EE_Systems*, call transaction RZ21, and choose *Technical Infrastructure* → *Configure Central System* → *Maintain System Groups*. The system ID of the J2EE Engine must be in the tree *System Groups for the Alert Monitor* → *J2EE_Systems*.
13. To check whether data has been transferred to CEN, call transaction RZ20, and choose the *Engines* monitor from the *SAP J2EE Monitor Templates* monitor set. There must be a <SID> subtree in the monitor.
14. Check whether you can change the threshold values of any performance node for the Java system from CEN (only if you have left the *enable CCMS Customizing* checkbox selected).

4.3.2. Registering a CCMS Agent SAPCCMSR (Double-Stack)



In the case of a double-stack system, you need to register the agent with two systems: primarily with the local ABAP system and secondarily with CEN. **You only need to register and start the agent once per system.**

If the J2EE Engine to be monitored is part of a double-stack system with both ABAP and Java instances, follow the procedure below to register a CCMS agent:

1. Log on the host of a J2EE Engine of the system as `<SID>adm`.
2. Copy the CSMCONF start file (see [Creating the CSMCONF Start File for CCMS Agents \[page 19\]](#)) to the following directory:

Windows: `[drive]:\usr\sap\ccms\\sapccmsr`

Unix: `/usr/sap/ccms/<SysID>_<Inst. No.>/sapccmsr`



You can also save the start file to any directory that you can access from your local host. In this case, however, you need to specify, during the registration of the agent, where you saved the file. To do this, choose the *Change ...* button in the *Monitoring* service of the Visual Administrator (see below), and specify the path of the start file. The file is then automatically copied to the above directory.

3. On the J2EE Engine's host, switch to the following directory:

Windows: `<J2EE home directory>\JC<Inst. No.>\j2ee\admin\`

UNIX: `<J2EE home directory>/JC<Inst. No.>/j2ee/admin/`



If you have installed the J2EE Engine together with an ABAP Engine, the letter combination in the name of the directory `JC<Inst. No.>` may vary.



4. Start the Visual Administrator by calling the start script `go` (UNIX) or `go.bat` (Microsoft Windows), and log on with your user as the J2EE Engine Administrator.
5. In the navigation bar, choose *Cluster* → *<SysID>* → *Dispatcher* → *Services* → *Monitoring*, and choose the *CCMS Agent Configuration* tab page.
6. If you want to monitor multiple systems with identical system IDs, select the *Long SID* indicator, and enter an identifier for the system in this input field that is unique within your system landscape. This “long system ID” must fulfill the following conditions:
 - The first three characters must be the system ID.
 - The name can consist of a maximum of eight characters.
 - The name must not contain an underscore (`_`).

7. Since you want to register the agent with two systems, you require the access data for two users for each of these systems, one of which is an administration user, and the other being the communication user CSMREG.
8. Specify the access data of these users for the local ABAP system by making all of the entries for the *Local Administration User* and *Local CSMREG User* rows. If necessary, you can overwrite the predefined values.
9. Specify the access data of these users for CEN by making all of the entries for the *CEN Administration User* and *CEN CSMREG User* rows. If necessary, you can overwrite the predefined values. The *CEN Administration User* is the user with administrator authorization with which you created the CSMCONF start file; the *CEN CSMREG User* is the user in CEN that you created under [Creating the CSMREG User \[page 18\]](#).

If you want to monitor the Java instances of your CEN, then the local ABAP system and the CEN are identical. In this case, you only see the entry for the local ABAP system.



If necessary, you can use the *Information* button to answer the following questions:

- Is the instance profile of the instance to be monitored valid?
 - Is the CSMCONF start file to be used valid?
 - What is the version of the CCMS agent SAPCCMSR?
10. Choose the *Register* button. The system displays the registration log; errors are highlighted in red.
 11. Under UNIX, the agent is automatically started by the `startsap` script when you start the J2EE Engine. Under Microsoft Windows, you need to start the associated service (which was created during the installation of the J2EE Engine) yourself.
To do this, on the Microsoft Windows host on which the agent is running, choose *Start* → *Settings* → *Control Panel* → *Administrative Tools* → *Services*, and choose the service *SAPCCMSR.<Instance No.>* by double-clicking it. Set the *Start Type* to *Automatic*, and choose *Start*.
- ### Checking the Agent Registration (Optional)
12. To check whether the agent was successfully registered with CEN, call transaction RZ21 in CEN, select the *Agents for Remote Systems* radio button, and choose  *Display Overview*. The agent that you have just registered is displayed in the list in the line `SAPCCMSR.<host name>.<inst. no.>`.
 13. To check whether the agent was successfully registered with the local ABAP system, call transaction RZ21 in the local ABAP system, select the *Agents for Local System* radio button, and choose  *Display Overview*. The agent that you have just registered is displayed in the list, in the line `SAPCCMSR.<host name>.<inst. no.>`.
 14. To check whether the J2EE Engine was included in the system group *J2EE_Systems*, call transaction RZ21, and choose *Techn. Infrastructure* →

Configure Central System → Maintain System Groups. The system ID of the J2EE Engine should be displayed in the tree *System Groups for the Alert Monitor → J2EE_Systems*.

15. To check whether data is being transferred to the CEN, call transaction RZ20, and choose the *Engines* monitor from the *SAP J2EE Monitor Templates* monitor set. If data is being transferred, there will be a subtree <SID> in the monitor.
16. Check whether you can change the threshold values of any performance node for the Java system from CEN (only if you have left the *enable CCMS Customizing* checkbox selected).

4.3.3. Displaying DSRs for the Java Instance in CEN

You can use the Global Workload Monitor to display statistical data for any components that write Distributed Statistics Records (DSRs). Components of this type are connected to the CEN using the CCMS agent SAPCCMSR. Here, there are two possible cases:

- If the CEN was defined as the primary system of the agent during registration, the monitored DSR component is automatically entered into the System Component Repository (SCR) of CEN. To display the DSRs of this component in the Global Workload Monitor (transaction ST03G), you only need to activate the component.
- If the was only defined as a secondary system during registration, you need to manually create an RFC connection between the secondary system and the primary system to be able to display the DSR statistics data for this component in CEN.



The case in which the CEN is defined as a secondary system of the agent occurs in particular in a monitored ABAP+Java system (double-stack). In this case, the SAPCCMSR CCMS agent that monitors a Java instance should be registered primarily with the local ABAP system and secondarily with CEN (see [Registering a CCMS Agent SAPCCMSR \(Double-Stack\) \[page 28\]](#)).



Prerequisites

For you to be able to display DSR statistics data in CEN, the job *SAP_COLLECTOR_FOR_NONE_R3_STAT* must be scheduled in CEN. To schedule the job, proceed as follows:



1. Start transaction SM36.
2. Choose *Standard Jobs*.
3. In the *SAP Component* input field, select the *BC Basis* using the possible entries help.
4. In the *Job Name* input field, select the entry *SAP_COLLECTOR_FOR_NONE_R3_STAT* using the possible entries help.
5. For the *Start Time*, choose the radio button *Immed.*, and for the *Period*, select the *Hourly* radio button.
6. Save your settings.

Displaying DSR Components in the Case of Primary Registration of the Agent with CEN

Step-by-Step



1. Start the Global Workload Monitor in CEN, by calling transaction ST03G.
2. In the navigation bar, expand the  *Settings & Log* subtree, and double-click the  *System Selection* entry.
3. Choose the button *Systems* → *Local*. All DSR components that are registered with CEN are displayed. For a Java instance, this is the J2EE Engine (component type *SAP J2ENode*) and the Java Database Interface (component type *SAP JDBI*).
4. Use copy and paste to transfer both of these entries to your list of monitored systems (see [Entering Monitored ABAP Systems in ST03G \[page 211\]](#)), and save the list that you have extended in this way by choosing the  button (*Save*) → *<desired list>*.
5. Ensure that you have checked the checkbox in the *Activated* column for all components for which you want to view statistical data, and choose the *Apply* button.

Checking the Entries (Optional)



6. To view the statistical data for one of the activated components, expand the path  *Workload* →  *<component name>* in the navigation bar.

Displaying DSR Components in the Case of Secondary Registration of the Agent with CEN

Step-by-Step



1. Start the Global Workload Monitor in CEN, by calling transaction ST03G.
2. In the navigation bar, expand the  *Settings & Log* subtree, and double-click the  *System Selection* entry.
3. Add an additional row to the desired list of monitored components by choosing the  (*Append Row*) button. Enter the following data in this row:

Column	Entry
<i>Activated</i>	Check the checkbox (together with the other components that you want to monitor)
<i>Component</i>	<p>Name under which the monitored system is displayed; use the following naming convention:</p> <ul style="list-style-type: none"> • J2EE Engine: <Engine-Host>_<SysID>_<Engine-ID> • Java Database Interface: <Engine-Host>_<Engine-SysID>_<Engine-ID>_JDBI. <p></p> <p>If you do not know the above name of the component, log on to the primary system of the agent, and start transaction ST03G in this system,</p>

Column	Entry
	too. As above, choose the buttons  <i>System Selection</i> and <i>Systems</i> → <i>Local</i> . The desired component is displayed in this list.
<i>Comp. Type</i>	SAPJ2ENode or SAPJDBI
<i>Mon. Sys.</i>	System ID of the primary system with which the agent is registered
<i>Mon. Sys. Dest.</i>	<p>RFC destination of the system ID of the primary agent system; if a suitable destination does not yet exist, create this using transaction SM59 (see also Creating RFC Destinations for Displaying Components in ST03G [page 22])</p> <p></p> <p>Alternatively, you can also use an indirect RFC destination to connect to the agent's primary system. To do this, enter in the <i>Indirect Destination</i> field the RFC destination of a system in CEN (such as the Solution Manager system), in which the required RFC destination to the agent's primary system <i>Mon.Sys. Destination</i>.</p>

4. Save the list that you have just added entries by choosing the  button (*Save*) → *<desired list>*.
5. Ensure that you have checked the checkbox in the *Activated* column for all components for which you want to view statistical data, and choose the *Apply* button.

Checking the Entries (Optional)

6. To view the statistical data for one of the activated components, expand the path  *Workload* →  *<component name>* in the navigation bar.

4.3.4. Configuring Availability Monitoring with the GRMG

You can use the Generic Request and Message Generator (GRMG) to monitor the availability both of technical components and of entire business processes. You define the required configuration settings in a GRMG Customizing file, which is transferred to CEN by a CCMS agent.



Note that for using GRMG it is necessary that the *Internet Communication Manager (ICM)* is configured and active on every ABAP instance of your system landscape.

Step-by-Step

7. On the J2EE Engine's host, switch to the following directory:

Windows: `<J2EE home directory>\JC<Inst. No.>\j2ee\admin\`

UNIX: `<J2EE home directory>/JC<Inst. No.>/j2ee/admin/`



If you have installed the J2EE Engine together with an ABAP Engine, the letter combination in the name of the directory `JC<Inst. No.>` may vary.

8. Start the Visual Administrator by calling the start script `go` (UNIX) or `go.bat` (Microsoft Windows), and log on as the J2EE Engine Administrator with your user.
9. In the navigation bar, choose *Cluster* → *Server* → *Services* → *Monitoring*, and choose the *GRMG Customizing* tab page.
10. Expand the left part of the screen. The system displays all applications for which there are prepared GRMG Customizing files. Select *sap.com/com.sap.engine.heartbeat*.
11. Transfer the Customizing file to the CCMS agent by choosing the  *Upload* button.

Checking the Configuration (Optional)

12. To check whether the GRMG monitoring was successfully activated, call transaction GRMG in CEN, and choose  *Upload/Download* → *Poll agents for new scenarios*.



Without manual polling, you need to wait up to an hour for the GRMG scenarios that you have uploaded in the Visual Administrator are transferred to CEN and started.

13. Select the scenarios that you have transferred to CEN, and choose  *Start*. Without manual polling, the GRMG scenarios transferred to CEN are started automatically.
14. Call transaction RZ20, and start the *Heartbeat* monitor in the *SAP J2EE Monitor Templates* monitor set.
15. Expand the *J2EE Engine* subtree. The system displays the monitored J2EE Engines that are monitored with the GRMG. You can see the J2EE Engine for which you have just configured availability monitoring under the naming convention *GRMG: J2EE <SysID> on <hostname>*. Check whether the nodes in that subtree have current values.

Back to the  [Overview](#)

4.4. Monitoring the Portal Infrastructure

Prerequisites:

- The portal has the NW 7.0 release and Support Package level discussed in this document.

- You have a user at operating system level (<SID>adm) on the host of the J2EE Engine, where <SID> is the system ID of the portal system.
- You have an administration user for the J2EE Engine.
- You have a user with administrator authorization in CEN.

4.4.1. Configuring Availability Monitoring with the GRMG

You can use the Generic Request and Message Generator (GRMG) to monitor the availability of the Portal Infrastructure. To do this, you define the required configuration settings in a GRMG Customizing file, which is transferred to CEN by a CCMS agent.

Step-by-Step

1. On the host of the J2EE Engine of the portal, switch to the following directory:

Windows: <J2EE home directory>\JC<Inst. No.>\j2ee\admin\
Unix: <J2EE home directory>/JC<Inst. No.>/j2ee/admin/



If you have installed the J2EE Engine together with an ABAP engine, the letter combination in the name of the directory JC<Inst. No.> in the above path may vary.

2. Start the Visual Administrator by calling the start script `go` (UNIX) or `go.bat` (Microsoft Windows), and log on with your user as a J2EE Engine Administrator.
3. In the navigation bar, choose *Cluster* → *Server* → *Services* → *Monitoring*, and choose the *GRMG Customizing* tab page.
4. Expand the left part of the screen. The system displays all applications for which a prepared GRMG Customizing file is available. Choose *sap.com/com.sap.portal.heartbeat*.
5. Transfer the Customizing file to the CCMS agent, by choosing  *Upload*.

Additional Steps in the Enterprise Portal



These steps are only required, if you are using a user name and password for authentication. Depending on your security strategy you can use user name/password or client certificate for authentication.



6. The GRMG scenario for the portal requires an authenticated user (with no special role). To authenticate the user, proceed as follows:
 - a) In the Portal, choose *System Administration* → *Permissions* → *Portal Permissions*.
 - b) Open the folder *Security Zones* → *sap.com* → *NetWeaver Portal* → *high safety* → *com.sap.portal.heartbeats* → *components* → *PortalHeartbeat*.
 - c) Select the *PortalHeartbeat* entry and switch to the Authorization Editor.
 - d) Add the desired user, assign the authorization *Administrator=Read* to the user, and check the *User* checkbox.
 - e) Save your entries.



For more information, see the SAP Help Portal under *SAP NetWeaver* → *SAP NetWeaver by KeyCapability* → *People Integration by Key Capability* → *Portal* → *Administration Guide* → *User Administration* → *Role Assignment* → *Assigning Roles to Users and Groups*, or follow the link below:

http://help.sap.com/saphelp_nw04s/helpdata/en/ED/845890B89711D5993900508B6B8B11/frameset.htm.

Additional Steps in CEN

7. Call transaction GRMG, and choose  *Upload/Download* → *Query CCMS Agent for Scenarios*. Confirm the following query.
8. The system displays a list that contains a scenario with the description GRMG:J2EE.PI<SID>:<Host> and the URL
http://<Host>:<Port>/irj/servlet/prt/portal/prtroot/com.sap.portal.heartbeats.PortalHeartbeat. Select the corresponding row, and choose  *Edit GRMG Customizing*.
9. Follow the appropriate procedure, depending on the type of authentication that you are using:

- Authentication using user name and password

Set the value **x** for the property USE_BASIC_AUTHENTICATION.

In the editable properties for the property names LOGON_USER and LOGON_PASSWORD, enter the values for the user that you created above.



The password is stored in encrypted form in the secure storage.

- Authentication using a **client certificate**



With this type of authentication, you must also replace the prefix **http** with **https** in the *URL/Destination* input field.

Add a row to the editable properties by choosing  *Add Row*. Enter the following values for the property:

Component	GRMG_RT
Version	1
Property Name	SSL_CLIENT_ID
Property Value	ANONYM (no certificate, only SSL encryption), DEFAULT (standard certificate of an SAP system), or the name of the SSL client PSE to be used



For more information about client certificates, see the Help Portal under *SAP NetWeaver* → *SAP NetWeaver by KeyCapability* → *Security* →

System Security → *System Security for SAP Web AS ABAP Only* → *Trust Manager* → *The PSE Types* → *SSL Client PSEs*, or follow the link below:
http://help.sap.com/saphelp_nw04s/helpdata/en/61/76893A9B323778E1000000A11402F/frameset.htm.

10. Save your changes.
11. Select the row for the scenario, and choose  *Start*.

Checking the Configuration (Optional)

12. In CEN, call transaction RZ20.
13. Expand the monitor set *SAP CCMS Monitor Templates*, and start the monitor *Availability and Performance Overview*. The system displays the availability of the activated scenarios in the subtree *GRMG-Tested Availability (Web Components)*.

Back to the  [Overview](#)

4.5. Monitoring TREX

Prerequisites:

- You have an operating system user with administration authorization on the host where the TREX server is running.
- On a UNIX system, you require the root user on the host.

4.5.1. Registering SAPCCMSR



After completion of the TREX installation, a CCMS agent is already entered in the TREX start profile and automatically started using a stand-alone option. With the stand-alone option, the agent runs so that the TREX tree is displayed only in your local SAP Management Console, communication with the central CCMS system is not possible until you have registered.

Step-by-Step (UNIX)

1. Log on to the TREX host as the root user.
2. Switch to the following directory:
`/usr/sap/<SysID>/TRX<instance number>`
 This is your installation directory for TREX <TREX_DIR>.
3. Set the environment variables required by TREX by executing the appropriate command for your UNIX shell:

Shell	Command
Bourne Shell (sh) Bourne Again Shell (bash) Korn Shell (ksh)	<code>. TREXSettings.sh</code>
C Shell (csh)	<code>source TREXSettings.csh</code>

4. To stop the CCMS agent, enter the following:
`sapccmsr pf=<instance_profile> -j2ee -standalone -stop`
 - You can find the CCMS agent in the directory `<TREX_DIR>/exe`.
 - The instance profile for your TREX installation has the following path
`/usr/sap/<SysID>/SYS/profile/<SAPSID>_TRX<instance number>_<host>`
5. Register the CCMS agent with the CEN:
`sapccmsr pf=<instance_profile> -j2ee -R`
6. Call the TREX start profile; the start profile has the following path:
`/usr/sap/<SysID>/SYS/profile/START_TRX<instance number>_<host>`
7. In the TREX start profile, change the launch of the CCMS agent:
Delete the parameter `-standalone` so that the following entry remains:
`sapccmsr pf=<instance_profile> -j2ee -DCCMS`

Step-by-Step (Windows)

1. Log on to the TREX host as an administrator.
2. Switch to the following directory:
`<drive>:\usr\sap\<SysID>\TRX<instance number>`.
This is your installation directory for TREX `<TREX_DIR>`.
3. Set the environment variables required by TREX by executing the following command: `TREXSettings.bat`.
4. To stop the CCMS agent, enter the following:
`sapccmsr pf=<instance_profile> -j2ee -standalone -stop`
 - You can find the CCMS agent in the directory `<TREX_DIR>\exe`.
 - The instance profile for your TREX installation has the following path
`<Drive>:\usr\sap\<SysID>\SYS\profile\
<SAPSID>_TRX<instance number>_<host>`
5. Register the CCMS agent with the CEN:
`sapccmsr pf=<instance_profile> -j2ee -R`
6. Call the TREX start profile; the start profile has the following path:
`<Drive>:\usr\sap\<SysID>\SYS\START_TRX<instance number>_<host>`
7. In the TREX start profile, delete the launch of the CCMS agent. Since the CCMS agent runs as a separate service after the registration in step two, an entry is not required.

4.5.2. Activating TREX Monitoring

To activate the monitoring of TREX, execute a corresponding script for each TREX instance on the TREX host. This activates, among other things, the following monitoring features:

- Availability monitoring with GRMG
- Process monitoring

- Monitoring with log files

Step-by-Step (UNIX)

1. Log on to the TREX host as the root user.
2. Switch to the following directory:
`/usr/sap/<SysID>/TRX<instance number>`
3. Set the environment variables required by TREX by executing the appropriate command for your UNIX shell:

Shell	Command
Bourne Shell (sh) Bourne Again Shell (bash) Korn Shell (ksh)	<code>. TREXSettings.sh</code>
C Shell (csh)	<code>source TREXSettings.csh</code>

4. Switch to the following directory, which contains the script:
`/usr/sap/<SysID>/TRX<instance number>/exe/CCMS`
5. Execute the script by executing the following command:
`./ccms_config.py --grmg`

Step-by-Step (Microsoft Windows)

6. Log on to the TREX host as an administrator.
7. Switch to the following directory:
`<drive>:\usr\sap\<SysID>\TRX<instance number>.`
8. Set the environment variables required by TREX by executing the following command: `TREXSettings.bat`.
9. Switch to the following directory, which contains the script:
`<drive>:\usr\sap\<SysID>\TRX<instance_number>\exe\CCMS`
10. Execute the script by entering the following command:
`ccms_config.py --grmg`

For a detailed description of the setup, see the document *Monitoring TREX with CCMS*. The document is attached to SAP Note 897226.

4.5.3. Displaying the DSRs for the TREX Instance in CEN

During the registration of the agent, the monitored TREX instance is automatically entered as a DSR component in the System Component Repository (SCR) of CEN. To display the DSRs for this component in the Global Workload Monitor (transaction ST03G), you only need to activate this component. You can activate this component in the same way as the J2EE Engine (see [Displaying DSRs for the Java Instance in CEN \[page 30\]](#)). The component type for TREX is *ST&TM*.

Back to the  [Overview](#)

4.6. Monitoring the Adobe Document Services

The Adobe Document Services are used to create and process PDF-based forms. These are used both in mass printing in backend systems and in interactive business processes.

Prerequisites:

- You have installed a J2EE Engine on the host of the services. The J2EE Engine has the NW 7.0 release and Support Package level discussed in this document.
- You have registered the SAPCCMSR agent in accordance with [Registering a CCMS Agent SAPCCMSR \[page 26\]](#) on the host of the services.
- You have installed the Adobe Document Services.

4.6.1. Configuring Availability Monitoring with the GRMG

You can use the GRMG to monitor the availability of the following components:

- Web Service interface
- XML Form module
- PDF Manipulation module

Prerequisites

A prerequisite for being able to activate the GRMG scenario is that the Web Dynpro PDF object is configured appropriately on the Adobe Document Services host. Make the exact settings, depending on the Web Service authentication procedure you are using, in accordance with the section *Configuring the Web Services* of the document *Configuration Guide - Adobe Document Services*.

You can find the above document under the Quick Link *adobe* in the SAP Service Marketplace (<http://service.sap.com/adobe>). Choose *Media Library* → *Documentation* → *Adobe Document Services - Configuration Guide NW 2004S*.

Step-by-Step

1. On the host of the J2EE Engine, switch to the following directory:

Windows: <J2EE Home directory>\JC<Inst. No.>\j2ee\admin\

UNIX: <J2EE Home directory>/JC<Inst. No.>/j2ee/admin/



If you installed the J2EE Engine together with an ABAP Engine, the character combination in the name of the **JC<Inst. No.>** directory in the above path may vary.

2. Start the Visual Administrator by calling the start script **go** (UNIX) or **go.bat** (Windows), and log on with your user as the J2EE Engine administrator.
3. In the navigation bar, choose *Cluster* → <SysID> → *Server* <x> → *Services* → *Monitoring*, and choose the tab page *GRMG Customizing*.
4. Expand the left half of the screen. All applications that have a prepared GRMG Customizing file are displayed. Choose `sap.com/tc~ads~grmg`.



The GRMG scenario is displayed in the Alert Monitor of the central monitoring system (CEN) in the subtree GRMG:ADS <SysID>:<Host>. To change the name of this subtree, select the entry *customizing* → *scenarios* → *scenario* → *scentexts* → *scentext* → *scendesc* → *GRMG:ADS...* on the subscreen Customizing tree for application, choose the  *Edit* button, and enter the desired name.

5. Transfer the Customizing file to the CCMS agent by choosing the  *Upload* button.

Checking the Configuration (Optional)

6. To check whether the GRMG monitoring was successfully activated, call transaction GRMG in CEN, and choose  *Upload/Download* → *Query CCMS Agent for Scenarios*.



Without manual polling, you would have to wait up to an hour for the GRMG scenarios that you have uploaded in the Visual Administrator to be transferred to CEN and started.

7. The scenario that you have just activated is displayed with its URL (*scenstarturl*) and description (*scendesc*).
8. Call transaction RZ20 and start the monitor *Adobe Document Services* from the *SAP J2EE Monitor Templates* monitor set.
9. Expand the *Heartbeat* subtree. You can find availability information for the Adobe Document Services there.

Back to the  [Overview](#)

4.7. Monitoring the Exchange Infrastructure

Prerequisites:

- You have installed an XI Java Component for which you want to monitor the availability with the GRMG.
- You have registered and started the CCMS agent SAPCCMSR on the host of this component in accordance with [Registering a CCMS Agent SAPCCMSR \[page 26\]](#).
- You have entered all systems of your XI infrastructure in CEN as monitored systems, in accordance with [Entering Monitored ABAP Systems in CEN \[page 19\]](#).

4.7.1. Making Adjustments in CEN

You must create the system group **ExchangeInfrastructure_Systems** so that all of the data for the XI infrastructure is displayed in the alert monitor. This system group must contain all of the systems of your XI infrastructure.

Step-by-Step

1. In CEN, call transaction RZ21.
2. Choose *Technical Infrastructure* → *Configure Central System* → *Maintain System Groups*.
3. Choose the button *Maintain Groups* → *Create System Group*, and enter **ExchangeInfrastructure_Systems** as the group name.
4. Expand the tree structure *System Groups for the Alert Monitor*, and select the system group that you have just created.
5. Choose the button *Maintain Systems* → *Create System*, and enter the system ID of one of the systems of your XI infrastructure.
6. Repeat the last step for all other systems in your XI infrastructure.

Checking the Adjustments (Optional)

7. In CEN, call transaction RZ20.
8. Expand the monitor set *SAP CCMS Monitor Templates*, and start the *Exchange Infrastructure* monitor.
9. This monitor displays data for all systems of the **ExchangeInfrastructure_Systems** system group.

4.7.2. Configuring Availability Monitoring with the GRMG

To monitor XI Java components with the GRMG, you must edit a corresponding template for a GRMG Customizing file and upload it to CEN.

Step-by-Step

1. Call up SAP Note 634771, and download the file **SAP_XI30_GRMG_Cust_Template.txt** from the attachment to the SAP Note. The template consists of six scenarios (enclosed by `<scenario>` ... `</scenario>`); each scenario represents a component that can be monitored with the GRMG:

Component	<scenname>	Path Prefix
Integration Repository	XI_REP1	rep/rtc
Integration Directory	XI_DIR1	dir/rtc
Runtime Workbench	XI_RWB1	rwb/rtc
System Landscape Directory	XI_SLD1	sld/rtc
J2SE Adapter Engine	XI_ADP1	rtc
J2EE Adapter Engine	XI_AF1	AdapterFramework/rtc

2. Delete from the template the scenarios that you do not want to monitor.
3. If you want to monitor multiple J2EE/J2SE Adapter Engines, copy the section for the relevant scenario in the template, insert the copied text between any two scenarios in the template, and change the value of the tag `<scenversion>` in the newly inserted scenario.

4. Log on to CEN, and create an RFC destination of type HTTP for each scenario in transaction SM59:

a) If the component is running on a J2EE Engine, enter G as the type of the RFC destination; otherwise enter H as the type. By default:

Component	Type
Integration Repository	G
Integration Directory	G
Runtime Workbench	G
System Landscape Directory	G
J2SE Adapter Engine	H
J2EE Adapter Engine	G



b) On the *Technical Settings* tab page, enter:

Field	Entry
<i>Target Host</i>	Name of the host on which the component is running
<i>Service Number</i>	Port number of the component; this are assigned during their installation and can also be determined in the SLD
<i>Path Prefix</i>	One of the value from the above table, depending on the monitored component

c) On the *Logon/Security* tab page, enter:

Field	Entry
<i>User</i>	Name of the user; we recommend that you use the user XIRWBUSER , which should be available on all components
<i>Password</i>	User password; XIRWBUSER has the (case-sensitive) initial password XIPASS  Note that the logon tickets generated in each case could be intercepted with HTTP connections. You should therefore always ensure that Secure Socket Layer (SSL) encryption is used or that both systems are in a protected environment.
<i>Security Options</i>	In the case of an RFC destination of type G , choose the <i>Basic Authentication</i> button.

d) Save your entries.

5. In the template, replace the value of the `<scenstarturl>` tag in the scenarios with the relevant name of the RFC destination of type HTTP that you created above.
6. Save the GRMG Customizing file.
7. In CEN, call transaction GRMG.
8. To upload the GRMG Customizing file to CEN, choose  *Upload*, and specify the above file.
9. Select the scenarios that you have just uploaded, and start them by choosing the  *Start* button.

Checking the Configuration (Optional)

10. In CEN, call transaction RZ20.
11. Expand the monitor set *SAP CCMS Monitor Templates*, and start the *Exchange Infrastructure* monitor. The system displays the availability of the activated scenarios.

Back to the  [Overview](#)

4.8. Monitoring a Standalone Database

Prerequisites:

- You have an operating system user with administrator authorization on the host of the standalone database.
- In the case of a UNIX system, you also require the root user on the host.

4.8.1. Installing SAPCCMSR and SAPOSCOL

SAPCCMSR and SAPOSCOL must be installed on every host of your monitored system landscape.

In the case of the individual components of SAP NetWeaver, the installation is performed at least semi-automatically; in the case of a standalone database, perform the following steps manually.

Step-by-Step

1. Log on to the relevant host as an administrator and create a separate directory for the installation (such as `install_mon`).
2. Copy the package `CCMAGENT.SAR` for your platform from the SAP Service Marketplace to the `install_mon` directory. Depending on your platform, use either the 32-bit version or the 64-bit version for SAP Web AS 6.40.

You can find the package in the area *SAP Support Packages and Patches* (<http://service.sap.com/swdc>) under *Download* → *Support Packages and Patches* → *Entry by Application Group* → *SAP NetWeaver* → *SAP NETWAEVER* → *SAP NETWAEVER 04* → *Entry by Component* → *Application Server ABAP* → *SAP KERNEL 6.40 32/64-BIT* → *<Platform>* → *Database Independent*.



If you can't find the package for your platform, use the corresponding package for SAP Web AS 6.20.

3. Copy the package **SAPOSCOL.SAR** for your platform from the SAP Service Marketplace to the **install_mon** directory. Depending on your platform, use either the 32-bit version or the 64-bit version for SAP Web AS 6.40. You can find the package in the same way as above.
4. Unpack the packages **CCMAGENT.SAR** and **SAPOSCOL.SAR** with the program **SAPCAR**. If you do not have the tool, download it from the same folder as the above packages. Use the following command for unpacking:

```
sapcar -xvf <package>
```

The **install_mon** directory now contains, among other things, the files **SAPOSCOL** and **SAPCCMSR** (name extensions depending on the platform).

5. Depending on your platform, download either the package **INSTALL_UX.SAR** or **INSTALL_WIN.SAR** from the attachment to SAP Note 704349 to the **install_mon** directory and unpack the archive.
6. Depending on your platform, proceed as follows:
 - o UNIX:
Log on as the root user and start **install_root.sh**.
Switch back to the original user and start **install_user.sh**.
 - o Microsoft Windows:
Execute the script **install.cmd**.
7. Copy the start file CSMCONF, which you created in accordance with [Creating the CSMCONF Start File for CCMS \[page 19\]](#), to the appropriate directory, depending on your platform:
 - o Windows: \\<hostname>\saploc\prfclog\sapccmsr
 - o UNIX: /usr/sap/tmp/sapccmsr
8. You must still register the CCMS agent with CEN and start it. Use the following command to do this:
 - o UNIX: /usr/sap/ccms/bin/sapccmsr -R
 - o Windows: \\<hostname>\saploc\prfclog\sapccmsr.exe -RDuring the registration, enter the passwords of the users to be used for communication with CEN, and confirm the other specifications.
9. Under UNIX, you must ensure yourself that SAPCCMSR and SAPOSCOL are automatically started again when the host is restarted. To do this, enter the following command in the **inittab (/etc/inittab)**:

```
/usr/sap/ccms/bin/saposcol  
/usr/sap/ccms/bin/sapccmsr -DCCMS
```

Checking the Configuration (Optional)

10. To check whether the agent was successfully registered with CEN, call transaction RZ21 in CEN, select the radio button *Agents for the Local System*, and choose  *Display Overview*. The agent that you have just registered appears in the list in the row SAPCCMSR.<host name>.99.
11. To check whether data is being transferred to CEN, call transaction RZ20, and start the *Operating System* monitor from the *SAP CCMS Monitor Templates* monitor set. There should be a subtree <host name> in the monitor, where <hostname> is the name of the host on which you have just installed SAPCCMSR and SAPOSCOL.

Back to the  [Overview](#)

4.8.2. Configuring Process Monitoring for the Database

The availability monitoring of the database is currently restricted to monitoring the processes at operating system level. Process monitoring requires the operating system collector SAPOSCOL and the CCMS agent SAPCCMSR.

Step-by-Step

1. Switch to the working directory of SAPOSCOL. This is \\<host>\saploc\prfclog (Microsoft Windows) or /usr/sap/tmp (UNIX).
2. Edit or create the file `dev_proc`. Ensure that the file begins with `$PROC` and ends with `$`. Depending on your platform and database, insert the following new line(s) between the start marker `$PROC` and the end marker `$`:

	MSSQL	ORACLE
UNIX		*ora_arc* *ora_reco* *ora_smon* *ora_ckpt* *ora_lgwr* *ora_dbw* *ora_pmon*
Microsoft Windows	*sqlservr.exe*	*oracle.exe*

3. Save your entries.
4. Under Microsoft Windows, open the Windows Service Manager and stop and restart the service SAPOsCol.
5. Under UNIX restart SAPOsCol manually; to do this, switch to /usr/sap/ccms/bin and enter the following commands:

```
saposcol -k (stops the process)
saposcol -l (starts the process)
```

Checking the Configuration (Optional)

6. Start transaction RZ20 in CEN, and open the *Operating System* monitor in the *SAP CCMS Monitor Templates* monitor set. The information about process monitoring is in the subtree <host name> → *Monitored Processes*.

Back to the  [Overview](#)

4.9. Monitoring the SAP Business Information Warehouse

Prerequisites:



- You have installed a BI Java component for which you want to monitor the availability with the GRMG.
- You have registered and started the CCMS agent SAPCCMSR on the host of this component in accordance with [Registering a CCMS Agent SAPCCMSR \[page 26\]](#).

4.9.1. Configuring Availability Monitoring with the GRMG

You can use the GRMG to monitor the following BW components for their availability (for more information, see SAP Note 706290):

- UDC Enterprise Beans
- SAP BI Java connectors
- Metamodel Repository
- RFC destination for the BW system

Step-by-Step

1. The UD Connect Bean file **bi_sdk_grmg.ear** contains a template for the GRMG Customizing file. The name of this file is **grmg-customizing.xml**. Copy this file to a location that can be accessed from your front end.
2. Call transaction GRMG in CEN.
3. Choose the  *Upload* button, and choose the above file **grmg-customizing.xml**.
4. Select the row with the name *BI UDC*, and choose the button  *Edit GRMG Customizing*.
5. Edit the input field *URL/Destination*. Replace **hostname** and **port number** with the corresponding values for your J2EE server on which you performed the deployment of UD Connect.
6. For the component *CONNECT0*, enter the value of the property name *JNDI_Name*. This is the JNDI name of a connector for which you have performed a deployment.

You can see the corresponding connectors in the Visual Administrator; to do this, choose *Cluster* → *Server* → *Services* → *Connector Container* in the navigation bar; you can see the JNDI name for the selected connector on the tab page *Runtime* → *Managed Connection Factory* → *Connection Definition*.

By default, the BI Java connectors have the following JNDI names:

Connector	JNDI Name
<i>BI JDBC Connector</i>	SDK_JDBC
<i>BI ODBO Connector</i>	SDK_ODBO
<i>BI SAP Query Connector</i>	SDK_SAPQ
<i>BI XMLA Connector</i>	SDK_XMLA

If you have cloned your connector, specify the name of the clone.

7. Create GRMG components for the other BI connectors:

- a) Choose the  Add Row button.
- b) Enter the following values in the new row:

Column	Value
<i>Component</i>	CONNECT<n> (start with 1 and increment upward for each additional connector)
<i>Version Type</i>	1
<i>Property Name</i>	JNDI_Name
<i>Property Value</i>	<JNDI name of the connector>

- c) Save your changes and confirm that you want to use a new component name.
 - d) Enter a description of the component. Use the following naming convention when doing so: **SAP BI Java Connectors <n>** (where <n> is the value specified above from **CONNECT<n>**).
 - e) Choose *Continue*, and confirm that you have created a new component
8. Adjust the specifications for the component **RFC**. By doing this, you specify the RFC destination for the BW system. You can find the corresponding values in the SAP Visual Administrator. To do this, choose *Cluster* → *Server* → *Services* → *JCo RFC Provider* in the navigation bar.

Choose the RFC destination of the BW system and transfer the values from the group box *Repository* to the following rows of the *Editable Properties*:

ApplicationServerHost
Client
Language
Password
SystemNumber
UserName

9. Save your changes, and exit the screen for editing the GRMG Customizing.
10. Select the scenario that you have just edited, and choose the  *Start Selection* button. As of this point, the scenario will be periodically executed.

Checking the Configuration (Optional)

11. After you have started the scenario, you can identify from the *Scenario Execution Status* whether the scenario was correctly executed. After the scenario is executed, there should be a green check mark here (✓).
12. To view the availability data for the monitored components, call transaction RZ20 in CEN, and start the *Heartbeat* monitor in the *SAP J2EE Monitor Templates* monitor set. Expand the subtree *BI UDC* → *GRMG: SAP BI UD Connect on <host name>*.

Back to the  [Overview](#)

4.10. Monitoring the SAP Mobile Infrastructure

For a detailed description, see the document *Installation of the SAP Mobile Infrastructure 2.5*, section *Configuration of the Computing Center Management System*.

You can find this document in the SAP Service Marketplace in the *SAP NetWeaver 04 Installation Information* area (<http://service.sap.com/nw04installation>). Choose the document *Installation Guide – SAP Mobile Infrastructure 2.5* from the list ([direct link](#)).

Back to the  [Overview](#)

5. Monitoring SAP NetWeaver 7.1 Systems

Until SAP NetWeaver 7.1 is generally available, you have to monitor components based on SAP NetWeaver 7.1 centrally using a CEN with release SAP NetWeaver 7.0. At the moment, this is true for the following products:

- SAP NetWeaver Composition Environment 7.1
- SAP NetWeaver Mobile 7.1

5.1. Monitoring SAP NetWeaver Composition Environment (CE) 7.1

Prerequisites:

- You have a user at operating system level on the host of the CE system (<SID>adm).
- You have an administration user for the CE system.
- You have performed the preparatory steps in CEN, as described in [Adjusting the Central Monitoring System \(CEN\) \[page 18\]](#).

5.1.1. Registering CCMS Agent SAPCCMSR

The monitoring data from the CE system is transferred to CEN using the CCMS agent SAPCCMSR. This agent is part of the system's installation package. Register the SAPCCMSR CCMS agent manually. To do this, perform the registration steps for all instances of the system.

Step-by-Step

1. Ensure that you have a CSMCONF start file created in CEN available (see [Creating the CSMCONF Start File](#) for CCMS [\[page 19\]](#).)
2. Log on to the host of the CE system as <SID>adm.
3. If it does not yet exist, create a `sapccmsr` directory in `$DIR_LOGGING` of the monitored instance. `$DIR_LOGGING` has the following path:
 Microsoft Windows: `[drive]:\usr\sap\<SID>\<instance directory>\log`
 Unix: `/usr/sap/<SID>/<instance directory>/log`
 The instance directory has the name `J<InstNumber>`.
4. Save the CSMCONF file to the `sapccmsr` working directory that you have just created for the agent.
5. Switch to the directory that contains the agent's executable, `sapccmsr` or `sapccmsr.exe`. Depending on your platform, this is:
 Microsoft Windows: `[drive]:\usr\sap\<SID>\<instance directory>\exe`
 UNIX: `/usr/sap/<SID>/<instance directory>/exe`



If the executable is not there, it is in the following directory:

Windows: `[drive]:\usr\sap\<SysID>\SYS\exe\uc\<platform>`

UNIX: `/usr/sap/<SID>/SYS/exe/uc/<platform>`

6. Start the agent with the following command:

```
sapccmsr -j2ee -r pf=<path of the instance profile>
```

By default, the complete path of the instance profile is:

Microsoft Windows:

```
c:\usr\sap\<SID>\SYS\profile\<SID>_J<InstNumber>_<Host>
```

```
UNIX: /usr/sap/<SID>/SYS/profile/<SID>_J<InstNumber>_<Host>
```

7. The agent reads the connection data for CEN from the CSMCONF start file, meaning that you only need to confirm it by pressing the ENTER key. You also need to enter the passwords for the two required users (CSMREG and the administrative user with which you created the CSMCONF start file).
8. Confirm other details, such as system groups to which the monitored system belongs or details for setting up the service by pressing the ENTER key.
9. Under Microsoft Windows, the agent is entered as a service during registration, and is automatically started when the host is restarted. Note that the user with which you register the agent must be a local administrator. Under UNIX, the agent is automatically started by the `startsap` script when you start the CE engine.

Checking the Agent Registration (Optional)

10. To check whether the agent was successfully registered with CEN, call transaction RZ21 in CEN, select the *Agents for Remote Systems* radio button, and choose  *Display Overview*. If the agent was successfully registered, the list contains a line `SAPCCMSR.<host name>.<Inst. Number>` for the agent that you have just registered.
11. To check whether the CE system has been added to the *J2EE_Systems* system group, call transaction RZ21, and choose *Technical Infrastructure* → *Configure Central System* → *Maintain System Groups*. If the CE system has been added to the system group, the system ID of the J2EE Engine is contained in the tree *System Groups for Alert Monitor* → *J2EE_Systems*.
12. To check if data is transferred to CEN, call transaction RZ20, and select the *Engines* monitor from the *SAP J2EE Monitor Templates* monitor set. If data has been transferred to CEN, there is a subtree `<SID>` in the monitor.

5.1.2. Creating a Customizing Destination

The Customizing destination allows you to change threshold values for the monitoring data for a Java instance in the Alert Monitor, too. With manual registration, you need to create the Customizing destination yourself by performing the following steps.





You need to create the Customizing destination in the NWA of the CE system in the work center *Configuration Management* → *Infrastructure Management* of the *Jco RFC Destination* plug-in. If this does not exist, perform a deployment as follows:

1. Call the Internet address <http://service.sap.com/monitoring>, and, in the navigation bar, choose *Download Area* → *EAR files for centrally monitoring CE 1.0 system*.
 2. Download the archive *JCo RFC Destination Plug-In*, and decompress the archive. The archive consists of three EAR files:
 - `sap.com~tc~je~trace~app.ear`
 - `sap.com~tc~lm~itsam~ui~services~jco~wd.ear`
 - `sap.com~tc~lm~itsam~ui~contentmodel~ear.ear`
 3. Perform a deployment with these three files in the order specified above. To do this, start the Eclipse SDK by executing the appropriate file for your platform:
`[drive]:\usr\sap\\J<InstNumber>\j2ee\deployView\DV_<platform>`.
 4. In the Deploy view, add the above files and then perform the deployment in the sequence above.
1. Create an RFC destination in the NWA of the CE system:
 - a) In the NetWeaver Administrator of the monitored CE system, choose *Configuration Management* → *Infrastructure Management* → *JCo RFC Destinations*.
 - b) Create a new RFC destination by choosing the *Create...* button.
 - c) Enter `SAP.CCMS.J2EE.<JSID>` as the name of the destination (where `<JSID>` is the system ID of the monitored CE system). Choose the *Next* button.
 - d) Enter the gateway connection data for the central monitoring system. Choose the *Next* button.

The *Gateway Service* has the naming convention `sapgw<InstanceNo.>`.
 - e) Enter the connection data for CEN. Choose the *Next* button.

If you do not have this data, you can find it in the CSMCONF start file in the agent's working directory.
 - f) Enter the name and password of an administrative user in CEN. Choose the *Next* button.
 - g) Continue through the remaining steps and create the destination by choosing the *Finish* button.
 2. Create an RFC destination in CEN:
 - a) To create an RFC destination, call transaction SM59, and choose  (*Create*).
 - b) In the *RFC Destination* input field, enter the name of the destination. Use the naming convention `SAP.CCMS.J2EE.<JSID>`, where `<JSID>` is the system ID of the monitored CE system.

- c) Enter **T** as the connection type, and enter a description of the destination. Confirm your entries by choosing  (*Continue*).
 - d) Switch to the *Technical Settings* tab page. In the *Activation Type* group box, select the *Registered Server Program* radio button, and in the *Program ID* input field, enter **SAP.CCMS.J2EE.<JSID>**.
 - e) In the *Gateway Options* group box, enter the gateway information for CEN, You have already used this information in the NWA when creating the RFC destination.
 - f) Save your entries.
3. Make this destination known to the monitoring infrastructure:
 - a) Call transaction RZ21.
 - b) In the *Topology* group box, select *Agents for Remote Systems*, and choose  *Display Overview*.
 - c) Switch to change mode by choosing the  (*Display ↔ Change*) button, and enter the name of the RFC destination **SAP.CCMS.J2EE.<JSID>** that you have just created for the agent in the *J2EE Customizing Destination* column.
 - d) Save your entries.

Checking the Customizing Destination (Optional)

4. Check whether you can change the threshold values for any performance node of the Java system from CEN.

5.1.3. Display the DSRs from the CE System in CEN

You can use the Global Workload Monitor to display statistical data for any components that write Distributed Statistics Records (DSR). Components of this type are connected to CEN using the CCMS agent SAPCCMSR.

Since the agent is always primarily registered with CEN in the case of a CE system, the monitored DSR component is automatically registered in the System Component Repository (SCR) of CEN. To display the DSRs for this component in the Global Workload Monitor (transaction ST03G), you only need to activate this component.

The procedure corresponds to the one of a Java only system with release SAP NetWeaver 7.0 (see [Displaying DSRs for the Java Instance in CEN \[page 30\]](#)).





5.1.4. Configuring Availability Monitoring with GRMG

You can use the Generic Request and Message Generator (GRMG) to monitor the availability of technical components and entire business processes. To do this, you specify the required configuration settings in a GRMG Customizing file, which is transferred to CEN by a CCMS agent.



Note that GRMG requires a configured and active *Internet Communication Manager (ICM)* on every ABAP instance of your CEN.

Step-by-Step

1. Call the Internet address <http://service.sap.com/monitoring>, and in the navigation bar, choose *Download Area* → *GRMG Customizing files* → *Application Server Java*.
Download the template *AS Java GRMG Monitoring Template* by right-clicking the  button.
2. Edit the downloaded file with a suitable XML editor. Change the values of the following tags:
 - **<scenstarturl>**: replace **[host]** with the host and **[port]** with the port of the monitored CE system
 - **<scendesc>**: replace **[sysID]** with the system ID and **[host]** with the host of the monitored CE systemSave the file.
3. In CEN, call transaction GRMG, choose  *Upload*, and specify the file that you have just downloaded.
4. Select the scenario that you have just uploaded, and choose  (*Edit GRMG Customizing*).
5. To start the availability monitoring, select the row for the scenario and choose the  *Start* button.

Checking the Configuration (Optional)

6. Call transaction RZ20, and start the *Heartbeat* monitor from the *SAP J2EE Monitor Templates* monitor set.
7. Expand the *J2EE Engine* subtree. The system displays the monitored Java Engines that are monitored with GRMG. The Java Engine of the CE system is displayed with the naming convention *GRMG: J2EE <SysID> on <host name>*. Check whether the nodes in this subtree have current values.

5.1.5. Activating Availability Monitoring for a CE System

To monitor the availability of a CE system using CCMSPING, you need to create an entry for the system in the list of monitored systems.

Step-by-Step

1. In CEN, start transaction RZ21, and choose the menu path *Technical Infrastructure* → *Availability Monitoring* → *Configure CCMSPING Availability Mon..*
2. Choose  *Monitoring* → *Create System*.
3. Specify the system ID of the CE system that you want to monitor, and choose the *Continue* button. The *Connection Data and Monitoring Options* screen appears.
4. In the *Connection Data: Java Message Server* group box, fill out the *Message Server Host Name* and *Message Server HTTP Port* input fields.
5. If you want to set monitoring options, make the appropriate entries.
6. Choose the *Copy Connection Data and Options* button.

7. Save your changes.

Back to  [Overview](#)

5.2. Monitoring ABAP Systems with Release SAP NetWeaver 7.1

Monitoring these systems correspond to monitoring ABAP systems with release SAP NetWeaver 7.0. So proceed as described in the following procedures:

- [Entering Monitored ABAP Systems in CEN \[page 19\]](#)
- [Entering Monitored ABAP Systems in ST03G \[page 21\]](#)
- [Registering a CCMS Agent SAPCCM4X \[page 24\]](#)

Back to  [Overview](#)

6. Configuration Steps for SAP NetWeaver Administrator

6.1. Overview

As of SAP NetWeaver 04 SP Stack 12, the SAP NetWeaver Administrator (NWA) is also available to you for landscape-wide administration and central monitoring. For current information about this, see the SAP Service Marketplace under the Quick Link *nwa* (<http://service.sap.com/nwa>).



The NWA runs as an application on the J2EE Engine and is called using the URL `http://<host>:<port>/nwa`.

To use the NWA for central monitoring, install a Java Add-In for your CEN, if it does not already have one. Since you can use the NWA not only for central monitoring, but also for central administration, the corresponding double-stack system is referred to as the *central administration and monitoring system*. This system is also abbreviated to CEN here.



Since the monitoring of the NWA is based on the monitoring infrastructure, you need to have performed the configuration steps to set up central monitoring, as described in section 4 (see [Prerequisites \[page 56\]](#)).

If you want to use the NWA to monitor your system landscape, you need a System Landscape Directory (SLD), since information about the monitored systems is stored in the SLD for this application. We recommend that you set up an SLD on the J2EE Engine of CEN for this purpose. This SLD is known as the *administrative SLD*.

In total, you need to perform the following configuration steps to use the NWA:

- You need to configure and start the administrative SLD; you also need to enter all ABAP and Java systems in your system landscape into this SLD (see [Setting Up the Administrative SLD \[page 63\]](#)).
- CEN must be able to write data about the agents of the monitored systems to the administrative SLD. You need to create special connections and authorizations for this (see [Configuring the Connection Between CEN and the SLD \[page 68\]](#)).
- You also need to set up a special RFC connection between the ABAP and the Java stacks of CEN (see [Configuring a Connection Between the ABAP and Java Stacks of CEN \[page 70\]](#)).
- If you want to use the NWA to administer multiple Java systems, we recommend that you store the corresponding logon data in the NWA's J2EE Engine, so that you do not need to log on with a user name and password every time (see [Storing Access Data for the Java Systems to Be Administered \[page 71\]](#)).



To simplify this step, the *Template Installer* is available in the NWA. You can use it to perform the above configuration steps more easily (see [Setting Up Using the Template Installer \[page 56\]](#)).

6.2. Prerequisites

The following prerequisites need to be fulfilled to set up the NWA:

- Since the monitoring in the NWA is based on the monitoring infrastructure, you need to have performed the configuration steps for setting up central monitoring described in section 4. In particular, the following sections require that you have performed the following configuration steps:
 - Monitored ABAP systems must be entered in transaction RZ21; see [Entering Monitored ABAP Systems in CEN \[page 19\]](#).
 - A CCMSPING availability agent must be installed and registered with CEN; see [Setting Up Availability Monitoring with CCMSPING \[page 23\]](#).
 - Monitored Java systems must be registered with CEN using the CCMS agent SAPCCMSR; see [Registering a CCMS Agent SAPCCMSR \(Java Standalone\) \[page 26\]](#).
 - We also recommend that you register the monitored ABAP instances with CEN using the CCMS agent SAPCCM4X; see [Registering a CCMS Agent SAPCCM4X \[page 24\]](#).
- You have activated the integrated Internet Transaction Server in the ABAP stack of CEN. This means that you can start analysis methods in the monitored ABAP systems from the NWA.

For more information, see the SAP Help Portal under *SAP NetWeaver* → *SAP NetWeaver by Key Capability* → *Application Platform by Key Capability* → *ABAP Technology* → *UI Technology* → *Web UI Technology* → *ITS / SAP@Web Studio* → *SAP ITS in the SAP Web Application Server* → *Installation and Activation*, or click the link below:

http://help.sap.com/saphelp_nw04s/helpdata/en/3d/b5f9c2ea65c242957ee504ca4a37a9/frameset.htm.

6.3. Setting Up Using the Template Installer

You can use the Template Installer to perform the configuration steps required to configure the SLD and the NWA more quickly and easily. With this method, the system requests the required specifications from you step-by-step, and then automatically performs the configuration steps.



Note that the setup using the Template Installer may only be used for the initial setup after installation. After upgrade use the manual setup of the NWA.

A particular advantage of this method is that you can perform all configuration steps in one central location (especially, if the SLD is running in CEN).

The configuration of the NWA is performed in multiple templates; to execute any one of these templates, you first need to switch to the corresponding area of the NWA:



Note that, to execute a template in the NWA, you must have activated *Local System Administration* in the *System Landscape Selection*.

Step-by-Step

1. Call the start page of the NWA using the URL `http://<host>:<port>/nwa;` `<Host>` and `<Port>` are the values for CEN's J2EE Engine, and log on as the J2EE Engine Administrator with your user.
2. In the top-level navigation, choose *Deploy and Change* → *Template Installer*.
3. In the *Scenario Template Identification* input area, choose the *NWA* entry from the *Scenario* dropdown list. The following templates are available to you to configure the NWA:

Name of the Template	Description
1. SLD system: Configure and activate SLD	Configure and Activate the Administrative SLD [page 58]
2. SLD system: Connect SLD to CEN (if CEN present)	Make Connection Settings Between CEN and SLD [page 59]
3. NWA system: Basic configuration	Basic Configuration of the NWA [page 59]
4. NWA system: Connect NWA to CEN (if CEN present)	Configure the Connections Between the ABAP and Java Stacks of CEN [page 60]
5. NWA system: Store access data per each managed Java system (optional)	Configure the Connections from the NWA to the Administered Java Systems [page 61]
6. NWA system: Register each managed ABAP system to SLD	Connect a Monitored ABAP System to the Administrative SLD [page 61]
7. Managed Java system: Register system to SLD	Connect a Monitored Java System to the Administrative SLD [page 62]

4. Execute the templates in the order specified by the numbering above.



- The same data (for example, access data for the administrative SLD) is sometimes required in different templates. In this case, the input fields already contain the corresponding input values from the previous template.
- When you execute a template, the *Guidance Area* shows one or more steps, with the current step highlighted in color. You can switch between the steps using the *Previous* and *Next* buttons. Enter the required data in the *Data Entry* area in each of these steps.

- After you have made all of the required specifications, choose the *Install* button. The configuration steps are automatically processed, and you are informed about the progress of these steps by the *Progress* bar and the *Administration* table.
- If you want to execute a template more than once in succession, choose the *Refresh* button in your browser between the two executions.

6.3.1. Configure and Activate the Administrative SLD

In this template, you perform the basic configuration of the administrative SLD. This includes the configuring and starting of both the *Object Server* and the *Data Supplier Bridge*. The template therefore corresponds largely to the manual steps in the section [Making Settings in the SLD \[page 64\]](#); however, without the two following steps:

- Setting the *Object Manager – BufferInstances* parameter
- Importing the CIM model data



Execute this template on the SLD host. We recommend that you run the administrative SLD on CEN; in this case, you can, of course, execute the template on CEN. If the SLD used is already configured and activated, you do not need to execute this template.

Step-by-Step

1. You are in the NWA on the SLD host, in the top-level navigation *Deploy and Change* → *Template Installer*, and have chosen *NWA* as the *Scenario* (see [Setting Up Using the Template Installer \[page 56\]](#))
2. Select the following entry from the *Template* dropdown list:
 1. *SLD system: Configure and activate SLD.*
3. Choose the *Execute Template* button.
4. *SLD data* is highlighted in the *Guidance Area*. Enter the connection data for the administrative SLD in the *Data Entry* area:

Input Field	Description
<i>SLD Host</i> <i>SLD Port</i>	Access data for the SLD (host and port)
<i>SLD Administration User</i> <i>Password</i>	Name/password of an administrator in the SLD
<i>Java System ID</i>	System ID of CEN
<i>SLD Gateway Service</i>	Service of a gateway (sapgw<System No.>). Use the CEN gateway.

5. Choose the *Install* button.

6.3.2. Make Connection Settings Between CEN and SLD

In this template, you create the required connections between the ABAP Engine of CEN and the administrative SLD. These are:

- The RFC connection SAPSLDAPI; an appropriate connection is also created in the SLD's J2EE Engine for this
- The access data for the SLD in transaction SLDAPICUST in the ABAP stack of CEN

The template therefore corresponds to the steps in [Configuring the Connection Between CEN and the SLD \[page 68\]](#), however without the connection from CEN's J2EE Engine to the administrative SLD using *CIM Client Generation Settings*. This is set in the template [Basic Configuration of the NWA \[page 59\]](#).



Execute this template on the SLD host. We recommend that you run the administrative SLD on CEN; in this case, you can, of course, execute the template on CEN.

Step-by-Step

1. You are in the NWA on the SLD host, in the top-level navigation *Deploy and Change* → *Template Installer*, and you have chosen *NWA* as the *Scenario* (see [Setting Up Using the Template Installer \[page 56\]](#))
2. Select the following entry from the *Template* dropdown list:
2. *SLD system: Connect SLD to CEN (if CEN present)*.
3. Choose the *Execute Template* button.
4. *ABAP connection data* is highlighted in the *Guidance Area*. In the *Data Entry* area, enter the connection data for CEN's ABAP Engine:

Input Field	Description
<i>ABAP User</i> <i>Password</i>	Name/password of an ABAP user in CEN
<i>Application Server Host</i> <i>System Number</i> <i>Client</i>	Access data for the ABAP Engine (application server, system number, and client)

5. In the *ToolBar* area, choose the *Next* button.
6. *SLD connection data* is highlighted in the *Guidance Area*. In the *Data Entry* area, enter the connection data for the administrative SLD (see [Configure and Activate the Administrative SLD \[page 58\]](#)).
7. Choose the *Install* button.

6.3.3. Basic Configuration of the NWA

With this template, you create the connection from CEN's J2EE Engine to the administrative SLD using *CIM Client Generation Settings* (see [Configuring the Connection Between CEN and the SLD \[page 68\]](#)).

Step-by-Step

1. You are in the NWA of CEN, in the top-level navigation *Deploy and Change* → *Template Installer*, and you have chosen *NWA* as the *Scenario* (see [Setting Up Using the Template Installer \[page 56\]](#))
2. Select the following entry from the *Template* dropdown list:
 3. *NWA system: Basic configuration*.
3. Choose the *Execute Template* button.
4. *Connection data (Java)* is highlighted in the *Guidance Area*. Enter the connection data for the J2EE Engine of the NWA in the *Data Entry* area:

Input Field	Description
<i>Java System ID</i> <i>Java Host & Port</i>	Access data for the J2EE Engine (System ID, host, and port)
<i>Java User</i> <i>Password</i>	Name/password of a user in the J2EE Engine

5. In the *ToolBar* area, choose the *Next* button.
6. *SLD connection data* is highlighted in the *Guidance Area*. Enter the connection data for the administrative SLD in the *Data Entry* area (see [Configure and Activate the Administrative SLD \[page 58\]](#)).
7. Choose the *Install* button.

6.3.4. Configure the Connections Between the ABAP and Java Stacks of CEN

This template consists of the following steps:

- Creating a JCo RFC connection from CEN's J2EE Engine to the ABAP stack of CEN (see [Configure the Connections Between the ABAP and Java Stacks of CEN \[page 70\]](#)).
- Activating the GRMG availability monitoring of the J2EE Engine (see [Configuring Availability Monitoring with the GRMG \[page 41\]](#)).

Step-by-Step

1. You are in the NWA of CEN, in the top-level navigation *Deploy and Change* → *Template Installer*, and you have chosen *NWA* as the *Scenario* (see [Setting Up Using the Template Installer \[page 56\]](#))
2. Select the following entry from the *Template* dropdown list:
 4. *NWA system: Connect NWA to CEN (if CEN present)*.
3. Choose the *Execute Template* button.
4. *Connection data (ABAP)* is highlighted in the *Guidance Area*. Enter the connection data of the ABAP Engine of CEN in the *Data Entry* area:

Input Field	Description
<i>Name of RFC Destination</i>	RFC destination for communication between ABAP and J2EE Engine of the CEN (naming convention SAP.CCMS.CEN.<SysID>)

Input Field	Description
<i>ABAP User</i> <i>Password</i>	Name/password of an ABAP user in CEN
<i>Application Server Host</i> <i>System Number</i> <i>Client</i>	Access data of the ABAP Engine (application server, system number, and client)

5. Choose the *Install* button.

6.3.5. Configure the Connections from the NWA to the Administered Java Systems

You can use this template to store logon data for remote Java systems in the NWA. If you want to administer multiple Java systems with the NWA, you do not then need to log on with a user name and password every time (see [Storing Access Data for the Java Systems to Be Administered \[page 71\]](#)).



Execute the template once for each remote Java system that you want to administer.

Step-by-Step

1. You are in the NWA of CEN, in the top-level navigation *Deploy and Change* → *Template Installer*, and you have chosen *NWA* as the *Scenario* (see [Setting Up Using the Template Installer \[page 56\]](#))
2. Select the following entry from the *Template* dropdown list:
5. NWA system: Store access data per each managed Java system (optional).
3. Choose the *Execute Template* button.
4. *Connection data (Java)* is highlighted in the *Guidance Area*. Enter the connection data of a remote Java system that you want to administer in the *Data Entry* area.
5. Choose the *Install* button.
6. Repeat the previous steps until you have executed the template for all Java systems to be administered.

6.3.6. Connect a Monitored ABAP System to the Administrative SLD

You can use this template to connect a monitored ABAP system to the administrative SLD, so that data for this ABAP system is available in the SLD. This template therefore corresponds to transaction RZ70 in the monitored ABAP system (see [Making Settings in the Monitored Systems \[page 65\]](#)).

Step-by-Step

1. You are in the NWA of CEN, in the top-level navigation *Deploy and Change* → *Template Installer*, and you have selected *NWA* as the *Scenario* (see [Setting Up Using the Template Installer \[page 56\]](#))
2. Select the following entry from the *Template* dropdown list:
6. NWA system: Register each managed ABAP system to SLD.
3. Choose the *Execute Template* button.

4. *Register ABAP System to SLD* is highlighted in the *Guidance Area*. In the *Data Entry* area, enter the connection data for a remote ABAP system for which data is to be available in the SLD.
5. In the *ToolBar* area, choose the *Next* button.
6. *SLD Bridge Gateway Data* is highlighted in the *Guidance Area*. Enter the connection data for the administrative SLD in the *Data Entry* area (see [Configure and Activate the Administrative SLD \[page 58\]](#)).
7. Choose the *Install* button.
8. Repeat the previous steps until you have executed the template for all remote ABAP systems that you want to monitor centrally.



Note that you also need to enter the ABAP Engine of CEN itself in this way.

6.3.7. Connect a Monitored Java System to the Administrative SLD

You can use this template to connect a monitored Java system to the administrative SLD so that data for the Java system is available in the SLD. This template therefore corresponds to the *SLD Data Supplier* service in the monitored Java system (see [Making Settings in the Monitored Systems \[page 65\]](#)).



This is the only template that you do not execute in the NWA of CEN, but rather in the NWA of the monitored system. If the monitored Java system does not have the required release status, you need to perform this step manually (see [Making Settings in the Monitored Systems \[page 65\]](#)).

If you want to monitor a CE system (see [Monitoring SAP NetWeaver Composition Environment \(CE\) 7.1 \[page 49\]](#)), you can not use this template. In this case, proceed as described in [Monitoring SAP NetWeaver Composition Environment \(CE\) 7.1 with NWA \[page 72\]](#).

Step-by-Step

1. You are in the NWA of a monitored system, in the top-level navigation *Deploy and Change* → *Template Installer*, and you have chosen *NWA* as the *Scenario* (see [Setting Up Using the Template Installer \[page 56\]](#))
2. Select the following entry from the *Template* dropdown list:
7. Managed Java system: Register system to SLD.
3. Choose the *Execute Template* button.
4. *Create Destination for SLD Data Supplier* is highlighted in the *Guidance Area*. Enter the following data in the *Data Entry* area:

Input Field	Description
<i>P4 Host</i>	Connection data of the local Java system, for which data is to be entered in the SLD; note that for the <i>P4 Port</i> applies: $P4 Port = HTTP Port + 4$
<i>P4 Port</i>	
<i>P4 User</i>	
<i>P4 Password</i>	

Input Field	Description
<i>SLD Host</i> <i>SLD Port</i> <i>SLD Administration User</i> <i>SLD Password</i>	Connection data of the SLD in which the above monitored Java system is to be entered

5. Choose the *Install* button.
6. Repeat the previous steps until you have executed the template in all remote Java systems that you want to monitor centrally.



Note that you also need to enter the J2EE Engine of CEN itself in the SLD in this way.

6.4. Setting Up the Administrative SLD

You require the SLD to monitor your system landscape if you want to use the SAP NetWeaver Administrator, since the information about the monitored systems is held in the SLD for this application. To be able to use the SLD, you need to configure and start the SLD itself, and also enter the ABAP and Java systems in your system landscape in this SLD.

For a summary of the steps necessary to do this, see also the document *System Landscape Directory 6.40: Getting Started – Checklist*. You can obtain this document from the SAP Service Marketplace, in the *System Landscape Directory* area (<http://service.sap.com/sld>). Choose *Media Library*, and then choose the document *SLD Getting Started - Check List* from the list ([direct link](#)).



- Note also the notes about the SLD in the *Master Guide – SAP NetWeaver 2004s*, section 4.2.3.4. You can obtain the Master Guide from the *Installation Information - SAP NetWeaver 2004s* area (<http://service.sap.com/installnw2004s>), by opening the *Planning* area ([direct link](#)).
- We recommend that you set up the administrative SLD on the J2EE Engine of CEN.

Landscape-Wide Monitoring with the NetWeaver Administrator: Setting Up an SLD

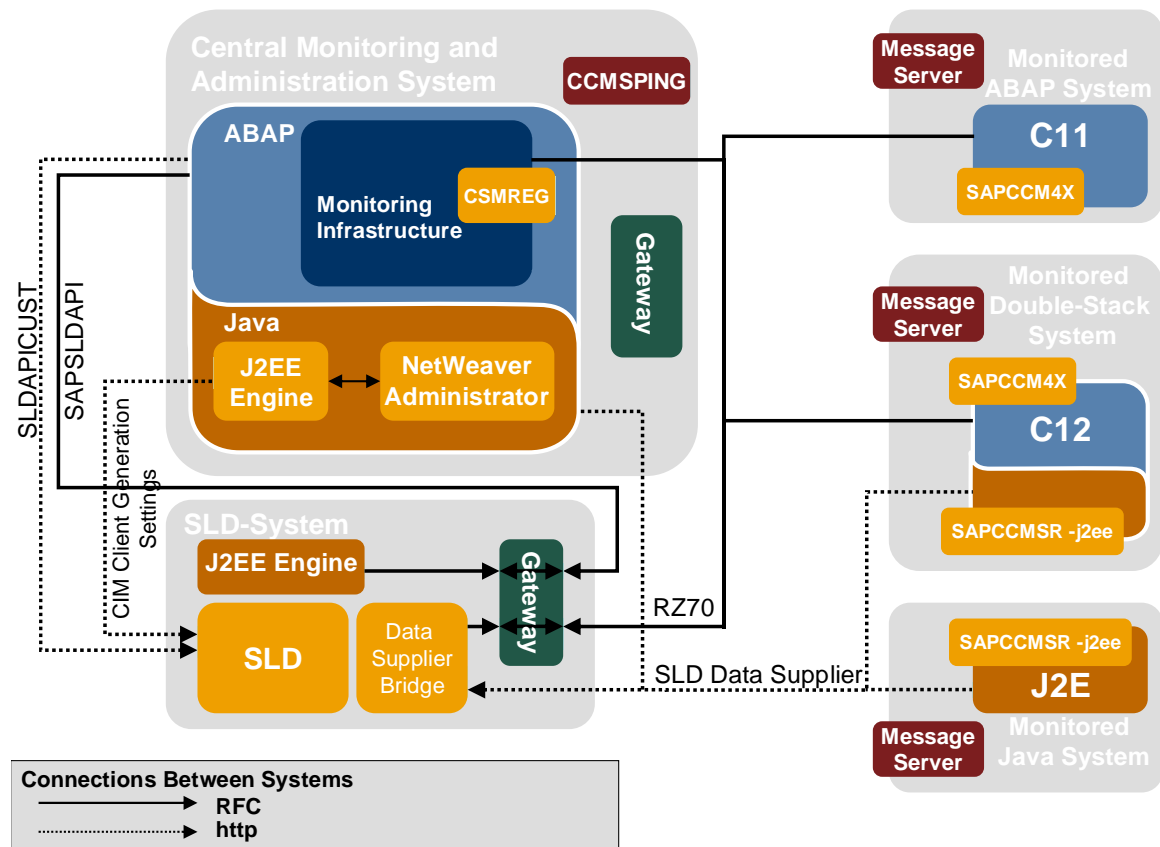

6.4.1. Making Settings in the SLD

The SLD is part of the J2EE Engine. To activate and configure an SLD, perform the following steps:



Some of the following steps are contained in [Configure and Activate the Administrative SLD \[page 58\]](#). Only the two steps below are not contained in that template:

Step	Description
3	Set the <i>Object Manager – BufferInstances</i> parameter
5	Import the CIM model data

Step-by-Step

1. Call the start page of the SLD with the URL `http://<host>:<port>/sld;` `<Host>` and `<Port>` are the values of the associated J2EE Engine.
2. Choose *Administration* → *Profile*, and select *Server Settings* in the dropdown listbox next to *Section*. Specify the host of the J2EE Engine on which the SLD is running in the *Object Server* input field. Choose *Save* and return to the *Administration* screen.



Note the parameter help for the *Object Server* input field (button).

3. If the Java system has multiple server nodes, choose the *ObjectManager* section, and set the parameter *BufferInstances* to the value *False*. Choose *Save*, and return to the *Administration* screen.
4. Start the server by choosing the *Start Server* button.
5. Start the import of the CIM model data about SAP components by choosing the *Import* button in the *Content* area; choose the document `<SAP Inst Dir.>\<SysID>\SYS\global\sld\model\CR_Content.zip`. Choose the *Import Selected File ...* button, and return to the *Administration* screen.



- This import takes a few minutes.
 - The CIM model must have at least the status 1.4.26. To check the status, choose *Details*, and choose the *Data* tab page. The version is displayed in the *Model Version* column of the table.
6. To be able to transfer information about the monitored systems to the SLD, you need to enter the connection data for an SAP Gateway in *Profile*, Section *datasupplier*. Enter the *GatewayHost* and the *GatewayService* (by default, `sapgw<System No.>`) to do this. Choose *Save*, and return to the *Administration* screen.



Use the SAP Gateway of the SLD system. If your SLD is running on a standalone Java system, install additionally a standalone SAP Gateway.

6.4.2. Making Settings in the Monitored Systems

So that the systems in your system landscape can deliver data to the SLD, you need to perform the following steps in all systems that you want to monitor centrally with the SAP NetWeaver Administrator (including in CEN itself):

Step-by-Step

1. To configure the SLD Data Supplier in an ABAP system, start transaction RZ70 in this system, and enter the data for the gateway service of the SLD that you set in the *Data Supplier Bridge*. Leave the other proposed values unchanged, and then choose the button (*Start Data Collection and Job Scheduling*).



For data from the monitored systems to be displayed in NWA, the following conditions need to be fulfilled, depending on the release of the monitored system:

Release	Condition
Up to 4.6D	System registered with CEN using CCMS agent SAPCCM4X (Patch Collection as of 2003/7) (see Registering a CCMS Agent SAPCCM4X [page 24])

Release	Condition
SAP Web AS 6.10	At least SP 37 and Kernel Patch Level 1157 (or alternatively, connection using the above agent SAPCCM4X)
SAP Web AS 6.20	At least SP 29 and Kernel Patch Level 1157 (or alternatively, connection using the above agent SAPCCM4X)

- To configure the SLD Data Supplier in a Java system, start the corresponding Visual Administrator, and log on as the J2EE Engine Administrator with your user.

In the navigation bar, choose *Cluster* → *Server* → *Services* → *SLD Data Supplier* → *Runtime*, and enter the connection data for the SLD on the *HTTP Settings* tab page. Save these settings by choosing the *Save* button, and start the data transfer by choosing the  button.



In the case of double-stack systems, you need to perform this step in both the ABAP and Java stacks.

Checking the Configuration (optional)

- Call the start page of the SLD again, and choose the *Technical Landscape* button. The systems in which you have performed the above configuration steps now appear in the SLD.

Note:

If there is already a productive SLD in your system landscape (for example, for XI), we recommend that you do not use this SLD as the administrative SLD for the NWA. Instead, configure a separate SLD in CEN for the NWA. To do this, proceed as follows:

- Leave the connections between the monitored systems and the existing SLD (as stated above, either through transaction RZ70 or using *SLD Data Supplier*) unchanged.
- Instead, define a forwarding of the registration data in the productive SLD in *Administration* → *Data Supplier Bridge* by choosing the *Add SLD...* button, and entering the connection data for the administrative SLD in the *New SLD Client* group box. Save your entries.



With the default settings, the monitored systems appear in the administrative SLD after a maximum of 720 minutes. To see the monitored systems there immediately, you need to manually restart the data transfer in these systems (transaction RZ70 or *SLD Data Supplier*).

- Create the connections from CEN to the administrative SLD in the usual way, in accordance with [Configuring the Connection Between CEN and the SLD \[page 68\]](#).

6.5. Manual Setup of the NWA



This section describes the individual steps that are required to set up the NWA. You can, however, have the Template Installer perform these steps; and we recommend that you do so, by following the instructions in the section [Setting Up Using the Template Installer \[page 56\]](#). Performing these steps manually is included here only for reasons of completeness.



Note that before the manual setup of the NWA, you have to execute the process [Setting Up the Administrative SLD \[page 63\]](#).

6.5.1. Configuring User Administration

There are four special roles available for the use of the NWA:

- `SAP_JAVA_NWADMIN_CENTRAL`
- `SAP_JAVA_NWADMIN_CENTRAL_READONLY`
- `SAP_JAVA_NWADMIN_LOCAL`
- `SAP_JAVA_NWADMIN_LOCAL_READONLY`

With these, you can either perform administration tasks only for the local system (*LOCAL*) or for all connected systems (*CENTRAL*), and can restrict the authorizations purely to display functions (*READONLY*).

Step-by-Step

1. Start the NWA, by calling the `http://<Host>:<Port>/nwa`; `<Host>` and `<Port>` are the values for the associated J2EE Engine.
2. In the top-level navigation, choose *System Administration* → *Administration*, and then, in *Detailed Navigation*, choose the *Identity-Management* entry.
3. To create a new user for operating the NWA, choose *Create User*, and enter the required data for the user.



If the data source of your identity management is an ABAP system, you may depending on the connection settings only be able to create new users in the ABAP engine.

4. To assign a specific role to a user, first enter the user name in the input field *Search Criteria*, and choose the *Go* button. Select the desired user in the list.
5. Choose the *Modify* button in the subscreen *Details of User...* Now choose the tab *Assigned Roles*, and enter the desired role in the input field *Search Criteria* of the subscreen *Available Roles*. Choose the *Go* button.
6. Select the role you want to assign to the user, and choose the *Add* button. When you have assigned all desired roles to the user, save your changes.

6.5.2. Configuring the Connection Between CEN and the SLD



For the operation of the NWA, the SLD needs to contain not only data about the monitored systems, which it contains through transaction RZ70 (ABAP systems) or the SLD Data Supplier service (Java systems), but also data about the agents that are monitoring these systems. To send this data to the SLD, you require special connections and authorizations in CEN:

- In the ABAP stack of CEN, the RFC connection SAPSLDAPI must be maintained; this RFC connection must also be maintained in the J2EE Engine of the SLD in the service *JCo RFC Provider*.
- The connection data for the SLD must exist in transaction SLDAPICUST in the ABAP stack of CEN.
- You also need to create a special connection with associated authorizations in the J2EE Engine of CEN (*CIM Client Generation Settings*).



In [Make Connection Settings Between CEN and SLD \[page 59\]](#) and [Basic Configuration of the NWA \[page 59\]](#), you can have these steps performed automatically. The system requests the data necessary to do so.

Step-by-Step

1. You need the connection data for the SLD in the ABAP stack of CEN. Therefore perform the following steps in the ABAP stack of CEN:
 - a) Start transaction SLDAPICUST.
 - b) Switch to change mode by choosing  (*Display ↔ Change*).
 - c) If there is not yet a corresponding connection to the desired SLD, create a new row by choosing  (*Append Row*).
 - d) Enter any *Alias Name*, the connection data for the SLD (*Host Name, Port*), and the name and password of an administration user on this SLD in the corresponding column of your new row.
 - e) Activate the *Prim.* Indicator for this connection.
 - f) Save your entries.
2. You need the RFC connection SAPSLDAPI in the ABAP stack of CEN. Therefore perform the following steps in the ABAP stack of CEN:
 - a) Create an RFC destination with the name SAPSLDAPI. Start transaction SM59, and choose the *Create* button. The *RFC Destination* screen appears.
 - b) In the *RFC Destination* input field, enter **SAPSLDAPI** as the name of the destination.
 - c) Enter **T** (*Start external program using TCP/IP*) as the connection type, and enter a description of the destination. Confirm your entries by choosing  (*Enter*).
 - d) Switch to the *Technical Settings* tab page. In the *Activation Type* group box, choose the *Registered Server Program* radio button, and enter any name in the *Program ID* input name. Note that you need to create a *JCo RFC Connection* with the same name in the J2EE Engine of the SLD (see point 3).

- e) In the *Gateway Options* group box, enter the gateway information for the data supplier bridge of your SLD (see [Making Settings in the SLD \[page 64\]](#)).
 - f) Save your entries.
3. To complete the RFC connection SAPSLDAPI, you also need to define an RFC connection in the J2EE Engine of the SLD. Therefore perform the following steps:
- a) Start the Visual Administrator and log on with your user as a J2EE Engine administrator.
 - b) In the navigation bar, choose *Cluster → Server → Services → JCo RFC Provider → Runtime*, and create a new RFC destination with the following connection data:

Input Field	Description
<i>Program ID</i>	Enter the name that you entered as the <i>Registered Server Program</i> under the SAPSLDAPI RFC connection in CEN (see point 2).
<i>Gateway host</i> <i>Gateway service</i>	Enter the connection data for the gateway for the data supplier bridge of the SLD (see Making Settings in the SLD [page 64]); by default, the gateway service uses the naming convention sapgw<System No.> .
<i>Number of processes</i>	Enter 3 here.
<i>Application server host</i> <i>System number</i>	Enter the connection data for a CEN application server here.
<i>Client</i> <i>Language</i> <i>User</i> <i>Password</i>	Enter the logon data for an administrator in CEN here.

- c) To create the connection, choose the *Set* button.

Checking the Configuration (Optional)

- d) In CEN, start transaction SLDCHECK. This also checks the RFC destination LCRSAPRFC, which you do not require for the NWA. You can therefore ignore this part of the test.
4. You need a special connection in the J2EE Engine to the SLD (*CIM ClientGeneration Settings*). Therefore, perform the following steps in the J2EE Engine of CEN:
- a) Start the Visual Administrator, and log on with your user as a J2EE Engine administrator.
 - b) You require (as in all monitored Java systems) a connection to the SLD. In the navigation bar, choose *Cluster → Server → Services → SLD Data Supplier → Runtime*, and enter the connection data for the SLD on the *HTTP Settings* tab page.

- c) To set the required authorizations for the NWA, now choose the *CIM Client Generation Settings* tab page, and activate the following entries in the list:
`sap.com/tc~lm~webadmin~mainframe~wd/webdynpro/public/lib/app.jar`
`sap.com/tc~lm~webadmin~sld~wd/webdynpro/public/lib/app.jar`
- d) Ensure that the SLD connection data is entered on this tab page, and save your entries by choosing *Save*.
- e) Activate the data transfer to the SLD by choosing

Checking the Configuration (optional)

- f) If you have correctly configured the connection, the *Central Administration* mode is now available to you in the NWA. Start the NWA, and choose the *Define System Selection* in *System Landscape Selection*.

If the connection to the SLD is functioning correctly, you can now display remote systems. In the *Landscape Type* input field, choose the *All Available Systems* entry, and choose *Start*. The system displays a list of the systems in the SLD. To switch to *Central Administration*, select the desired systems and choose *OK*.

6.5.3. Configuring a Connection Between the ABAP and Java Stacks of CEN

You need to create a Jco RFC connection to the ABAP stack of CEN in the J2EE Engine with the naming convention `SAP.CCMS.CEN.<SID>`.



In [Configure the Connections Between the ABAP and Java Stacks of CEN \[page 60\]](#), you can have this step performed automatically. The system requests the information it requires when doing so.

Step-by-Step

1. Start the Visual Administrator for the J2EE Engine of CEN, and log on with your user as a J2EE Engine administrator.
2. In the navigation bar, choose *Cluster* → *Server* → *Services* → *JCo RFC Provider* → *Runtime*, and create a new RFC destination with the following connection data:

Input Field	Description
<i>Program ID</i>	Enter the following program ID: <code>SAP.CCMS.CEN.<SID></code> , where <code><SID></code> is the system ID of CEN.
<i>Gateway host</i> <i>Gateway service</i>	Enter the connection data for the CEN gateway here; by default, the gateway service has the naming convention <code>sapgw<System No.></code> .
<i>Number of processes</i>	Enter 1 here.
<i>Application server host</i> <i>System number</i>	Enter the connection data for a CEN application server here.

Input Field	Description
<i>Client</i> <i>Language</i> <i>User</i> <i>Password</i>	Enter the logon data for a user in CEN here. The user requires authorizations to call transaction RZ20 (Alert Monitor).

- To create the connection to the ABAP stack of CEN, choose the *Set* button.

Checking the configuration (Optional)

- Start the NWA, and choose *System Management* → *Monitoring* in the top-level navigation. In *Detailed Navigation*, choose the *Central Reports* entry.
- If you have created the connection to the ABAP stack of CEN correctly, you can display a monitor set and a monitor from CEN in the dropdown lists for the input fields *View Set* and *View*. If the connection is not functioning correctly, the dropdown lists remain empty.

6.5.4. Storing Access Data for the Java Systems to Be Administered



In [Basic Configuration of the NWA \[page 59\]](#), you can have these steps performed automatically. The system requests the information it requires when doing so.

If you want to administer multiple Java systems with the NWA, we recommend that you store the relevant logon data in the J2EE Engine of CEN, so that you do not need to log on with a user name and password every time.

- Start the Visual Administrator for the J2EE Engine of CEN, and log on with your user as a J2EE Engine administrator.
- In the navigation bar, choose *Cluster* → *Server* → *Services* → *Destinations* → *Runtime*, and select the *HTTP* in the destination tree. Choose the *New* button.
- Enter the following name:

`sap.com/tc~je~jmx~wsconnector~sp/<SysID>/<DB Host>`

`<SysID>` is the system ID of the Java system to be administered; `<DB Host>` is the host on which the database of this system is running.



- Note that `<DB-Host>` is case-sensitive.
 - In a central system, the database host is simply the host on which the Java system itself is running.
 - In the case of named MSSQL instances, enter the following name:
`sap.com/tc~je~jmx~wsconnector~sp/
<SysID>/<DB Host>/<DB Instance>`
- On the next screen, enter the following URL:
`http://<j2eehost>:<port>/WSConnector/Config1?style=document`
`<j2eehost>` is the host of the central instance of the Java system to be administered; `<port>` is the HTTP port of the J2EE Engine.

5. In the *Authentication* input field, choose the *BASIC* entry from the dropdown list.
6. In the *User Name* and *Password* fields, enter the corresponding data for a user with administrator authorization in the Java system to be administered.
7. Save your entries by choosing the *Save* button.

Checking the Configuration (Optional)

8. Start the NWA and choose *System Management* → *Administration* in the top-level navigation. In the *Detailed Navigation*, choose the *Systems* entry.
9. A list of the Java systems to be administered appears. If you expand the tree for a system for which you stored access data above, you do not need to make any additional entries to log on to this system.

6.6. Monitoring SAP NetWeaver Composition Environment (CE) 7.1 with NWA

It is a prerequisite for this chapter that an NWA is already configured for central monitoring in CEN. Only the steps required to monitor a CE system from the NWA are described here.

6.6.1. Connecting the CE System to the Administrative SLD

To monitor the CE system from NWA, you need to register the system in the administrative SLD.

Step-by-Step

1. In the NetWeaver Administrator of the monitored CE system, choose *Configuration Management* → *Security Management* → *Destinations*.
2. If it does not yet exist, create an HTTP destination with the name **SLD_DataSupplier**. If the connection exists already, change it by choosing the *Edit* button.
3. In the *Connection and Transport* area, enter the **http://<host>:<port>** in the *URL* input field, where **<host>** and **<port>** are the host name and port number of the administrative SLD.
4. Switch to the *Logon Data* area. In the *Authentication* input field, select the *Username and Password* entry, and specify the user name and password of an SLD user.
5. Save your changes.
6. If it does not yet exist, create an HTTP destination with the name **SLD_Client**. If the connection already exists, change it by choosing the *Edit* button.
7. In the *Connection and Transport* area, enter **http://<host>:<port>** in the *URL* input field, where **<host>** and **<port>** are the host name and port number of the administrative SLD.
8. Switch to the *Logon Data* area. In the *Authentication* input field, select the *Username and Password* entry, and specify the user name and password of an SLD user.
9. Save your changes.

10. In the NetWeaver Administrator of the monitored CE system, choose *Configuration Management* → *Infrastructure Management* → *SLD Data Supplier Configuration*.
11. To transfer the system data to the SLD, choose the *Collect and Send Data* button.

Checking the Transfer (Optional)

12. The system displays the result of the transfer.

6.6.2. Creating the Required Associations for the CE System in the SLD

Immediately after you have connected the CE system to the administrative SLD, this system is missing the association *Centrally Monitored Application System* in the SLD. This association specifies that the system is monitored by CEN.

Step-by-Step

1. Reset the central instance of CEN to WARMUP status:
 - a) In CEN, call transaction RZ21, and choose *Technical Infrastructure* → *Display Topology*.
 - b) Choose the *Local Segments (<System-ID>)* tab page, and switch to change mode by choosing the *Display ↔ Change* () button.
 - c) Select the segment for the central instance (*SAP_CCMS_<host name>_<system ID>_<instance number>*), and choose the button *Reset Segment in WARMUP Status*. In the messages that follow, confirm that you want to start the startup methods again.
2. Restart the NWA.

Checking the Transfer (Optional)

3. To determine whether the association exists, call the administrative SLD and choose the *Administration* button.
4. Display the associations of the CE system. To do this, choose the *Content Maintenance* button, choose the *All with Classes* entry from the *Subset* drop-down list, and choose the *SAP J2EE Engine Cluster* entry from the *Classes* drop-down list. The CE system is displayed in the list of systems. Choose the corresponding entry in the *Assoc's* column.
5. The *Centrally Monitored Application System* association exists, and CEN is specified as *Dependent*.

6.6.3. Configuring the Connections from the NWA to CE Systems

If you want to monitor multiple CE systems with the NWA, we recommend that you store the corresponding logon data in the Java Engine of CEN so that you do not need to log on with a user name and password every time.

1. Start the Visual Administrator for the CEN's Java Engine, and log on as the Java Engine administrator with your user.

2. In the navigation bar, choose *Cluster* → *Server* → *Services* → *Destinations* → *Runtime*, and select the *HTTP* entry in the destination tree. Choose the *New* button.

3. Enter the following name:

`sap.com/tc~je~jmx~wsconnector~sp/<SysID>/<DB Host>`

<SysID> is the system ID of the CE system to be administered; <DB Host> is the host on which the data for this system is running.



- Note that <DB Host> is case-sensitive.
- In the case of a central system, the database host is simply the host on which the CE system itself is running.
- In the case of specified MSSQL instances, enter the following name: `sap.com/tc~je~jmx~wsconnector~sp/<SysID>/<DB Host>/<DB Instance>`

4. On the next screen, enter the following URL:

`http://<cehost>:<port>/WSConnector/Config1?style=document`

<cehost> is the host of the central instance of the CE system to be administered; <port> is the HTTP port of this system.

5. In the *Authentication* input field, select the entry *BASIC* from the drop-down list.
6. In the *Username* and *Password* input fields, enter the corresponding data for a user with administrator authorizations for the CE system to be administered.
7. Save your entries by choosing the *Save* button.

Checking the Configuration (Optional)

8. Start the NWA, and in the top-level navigation, choose *System Administration* → *Administration*. In the *Fine Navigation*, choose the *Systems* entry.
9. The system displays a list of the Java systems to be administered. If you expand the tree for a system for which you stored the access data above, you do not need to make additional entries to log on to that system.

6.7. Problem Analysis Scenario for the Setup of the NWA



The possible error situations that can occur when calling monitoring in the NWA are described in this section, together with their causes and solutions:

Symptom	When calling the NWA, you receive the following error message: Server for System Landscape Directory was not started. Only local system management can be used.
----------------	---

Cause 1	The object server of the SLD is not running.
Solution 1	Start the object server as described in Making Settings in the SLD [page 64] .

or

Cause 2	The access data for the SLD is not maintained in the <i>CIM Client Generation Settings</i> of the J2EE Engine of CEN.
Solution 2	Enter the access data as described in Configuring a Connection Between the ABAP and Java Stacks of CEN [page 70] .

Symptom	When calling the NWA, you receive the following error message:  No access possible to the System Landscape Directory.  Only local system management can be used.
----------------	--

Cause	The authorizations in the SLD are not maintained in the <i>CIM Client Generation Settings</i> of the J2EE Engine of CEN.
Solution	Enter authorizations as described in Configuring a Connection Between the ABAP and Java Stacks of CEN [page 70] .



Symptom	You cannot display any monitor sets or monitors in the <i>Monitoring → Central Reports</i> work center of the NWA.
----------------	--

Cause	The RFC connection <code>SAP.CCMS.CEN.<SID></code> from the Java stack to the ABAP stack of CEN has not been created or was created incorrectly.
Solution	Create the above RFC connection as described in Configuring a Connection Between the ABAP and Java Stacks of CEN [page 70] .

Symptom	You want to monitor a particular system. However, it is not shown in the <i>System Landscape Selection</i> .
----------------	--

Cause	The relevant system does not exist in the SLD.
Solution	Use transaction RZ70 (ABAP systems) or the <i>SLD Data Supplier</i> (Java systems) to enter the relevant system in the SLD (see Making Settings in the Monitored Systems [page 65]).

Symptom	The desired ABAP system contains only the following entry in the <i>Monitoring → Central Reports</i> work center:
----------------	---

	<p> No monitoring data available.</p> <p>If you call the <i>System Overview</i> in the Topology Display of the ABAP stack of CEN (transaction RZ21), you see an entry for the relevant system. Select this entry and choose the  <i>Test Single Connection</i> button. The connection test returns an error.</p>
--	--

Cause	No monitoring data is available for the system in the monitoring infrastructure of CEN.
Solution	Use transaction SM59 to check and correct the RFC connections to the relevant system from the ABAP stack of CEN. You can see the corresponding RFC connections in the Topology Display.

Symptom	<p>The desired ABAP system contains only the following entry in the <i>Monitoring</i> → <i>Central Reports</i> work center:</p> <p> No CEN information available in SLD.</p>
----------------	---

Cause	The system is missing the association <i>Centrally Monitored Application System</i> in the SLD. This specifies that the system is monitored by CEN.
Solution	<ol style="list-style-type: none"> 1. Check whether CEN is entered in the SLD under <i>BC System</i>. If not, use transaction RZ70 to enter CEN in the SLD (see Making Settings in the Monitored Systems [page 65]). 2. Reset the central instance of CEN to WARMUP status: <ol style="list-style-type: none"> a) Call transaction RZ21 in CEN, and choose <i>Technical Infrastructure</i> → <i>Display Topology</i> there. b) Choose the <i>Local Segments (<System ID>)</i> tab page, and switch to change mode by choosing the <i>Display ↔ Change</i> (). c) Select the segment for the central instance (<i>SAP_CCMS_<host name>_<system ID>_<instance number></i>), and choose the <i>Reset Segment in WARMUP Status</i> button. Confirm in the following dialog boxes that you want to restart the startup methods. 3. Restart the NWA. 4. If this procedure does not bring success, check the following subtree of the <i>CCMS Selfmonitoring</i>

	<p>monitor in the <i>SAP CCMS Technical Expert Monitors</i> monitor set for alerts: <i>MoniInfra_ <central instance> → DataSupplier → Log</i></p>
--	--

Background information about the above error:

When you enter a remote system in the monitoring infrastructure (or register an agent with CEN), an association is automatically created in the SLD that indicates that the corresponding system is monitored by CEN. You require this association, called *Centrally Monitored Application System*, to be able to display monitoring data for the system in the NWA.

If you have already set up central monitoring, and only configure the SLD later, this association is created by a startup method. Methods of this type are automatically started when the system is booted.

However, it is not guaranteed that the SLD is already running at this point. We therefore recommend that you created the required associations by manually starting the method (**CCMS_SCR_SLD_Consistency_Check**). To do this, reset the central instance of CEN to WARMUP status, to start all startup methods again.

Symptom	No availability data is displayed for a system in the <i>Monitoring → Availability</i> work center; the current status is  (<i>Not configured</i>).
----------------	--

Cause 1	The availability agent CCMSPING is not installed. In this case, if you select any monitored system, you cannot assign it a <i>CCMSPING Target</i> on the <i>Configuration</i> tab page.
Solution 1	Install the agent in accordance with the information in the document <i>Availability Monitoring and CCMSPING</i> (see Setting Up Availability Monitoring with CCMSPING [page 23]).

Cause 2	Availability monitoring is not active for the relevant system.
Solution 2	<p>Select the relevant system, specify the <i>CCMSPING Target</i> and a short description of the system on the <i>Configuration</i> tab page, and choose the <i>Activate Availability Monitoring</i> button.</p> <p style="text-align: center;"></p> <p>You can also perform these configuration steps directly in the ABAP stack of CEN. To do this, start transaction RZ21, and choose <i>Technical Infrastructure → Availability Monitoring → Configure CCMSPING Monitoring</i>.</p>

7. Moving a Central Monitoring System

This section describes how you can transfer the settings of a central monitoring system CEN1, and if necessary of an SAP NetWeaver Administrator (NWA) to another system, CEN2. There is not currently an automated way of moving the central monitoring settings and the manual steps are therefore listed in the following.



This section is not part of an initial setup; it is only part of the Monitoring Setup Guide, because the initial steps are also performed when moving of CEN.

A move of this type could be required in the context of an upgrade, or also if the central CCMS monitoring system and the Solution Manager are to run on one system.

Moving a central monitoring system means, on the one hand, that you need to transfer the Customizing settings that are stored in CEN1 to the new system, CEN2. On the other hand, you need to register CCMS agents, which have stored local connection data to the central monitoring system, with the CEN2 system.



You only need to perform some of the steps if you are using the NWA in the context of your landscape-wide monitoring (these are correspondingly indicated by a note). In this case, you need to clarify if you also want to move the administrative SLD (which contains the data for the monitored systems) during the move. When making this decision, you need to decide between two possible scenarios:

- The administrative SLD remains in the previous system, and therefore is not included in the move. This is primarily the case if you are using a central SLD that is not running in system CEN1.
- You want to set up a new administrative SLD in the context of the move; that is, it is involved in the move. This is primarily the case if the previous administrative SLD is running in system CEN1. In this case, you need to adjust the connection data of all monitored systems to the SLD.

Prerequisites

In the context of these steps, you repeatedly need to transport table contents or other data from the original monitoring system CEN1 to the new monitoring system CEN2. It is therefore a prerequisite of this section that you are familiar with the Change and Transport System. You must be able to create a transport request, and to import a transport request into the target system.



For more information, see the SAP Help Portal under *SAP NetWeaver* → *SAP NetWeaver by Key Capability* → *Solution Life Cycle Management by Key Capability* → *Software Life Cycle Management* → *Software Logistic* → *Change and Transport System*, or follow the link below:

http://help.sap.com/saphelp_nw04s/helpdata/en/14/94fc3f8fc2c542e10000000a1550b0/frameset.htm.

The steps in detail:



You only need to perform the steps in any particular section if you have made configuration settings in this area in CEN1.

7.1. Preparatory Steps in CEN2

7.1.1. Release and Patch of the New Central Monitoring System CEN2

CEN2 should have a SAP NetWeaver release with current Support Package Stack, that is, depending on the release:

- NW 2004 SPS 19
- NW 7.0 SPS 12

Ensure that the kernel of CEN2 is at least at the Patch Level specified in SAP Note 827872 (for SAP NetWeaver 04 (6.40), this is at least Kernel Patch 81).

7.1.2. Create Dispatching and CSMREG in CEN2

You need to perform the following steps manually in CEN2:

- You need to follow the instructions for [Activating Background and Central System Dispatching\[page 18\]](#) for CEN2.
- You need to follow the instructions for [Creating the CSMREG User \[page 18\]](#) in CEN2.

7.2. Steps for Moving the NWA

7.2.1. Initial Configuration of and Data Provision for the New Administrative SLD



You only need to perform this step if you use the NWA in the context of your landscape-wide monitoring **and** are setting up a new administrative SLD in the context of the move.

Perform the following steps for the new SLD:

- Set the corresponding host name and start the object server.
- Set the corresponding host name and start the data supplier bridge.
- Perform the initial import of the CIM model data.



For a detailed description of these steps, see [Making Settings in the SLD \[page 64\]](#).

- You then need to enter the connection data for the new SLD in all monitored systems, either in transaction RZ70 (ABAP), or in the *SLD Data Supplier* service

(Java), and start the data transfer (see [Making Settings in the Monitored Systems \[page 65\]](#)).

7.2.2. Configuring the NWA



You only need to perform this step if you use the NWA in the context of your landscape-wide monitoring.

Perform the steps as described in the [Manual Setup of the NWA \[page 67\]](#) section or [Setting Up Using the Template Installer \[page 56\]](#). When doing so, enter the connection data for the administrative SLD that you want to use for CEN2.

7.3. Deregistering/Registering CCMS Agents

You need to deregister all CCMS agents that are registered with CEN1, and register them with CEN2. There is no system support for doing this, that is, you need to perform the steps manually in accordance with the usual instructions:

- [Registering a CCMS Agent SAPCCM4X \[page 24\]](#)
- [Registering a CCMS Agent SAPCCMSR \(Java Standalone\) \[page 26\]](#)
- [Registering a CCMS Agent SAPCCMSR \(Double-Stack\) \[page 28\]](#)

You perform the deregistration in the same way as registration. You only need to note the following points:

- For manual deregistration (SAPCCM4X), replace the parameter **-R** for registration with **-U** (*Unregister*).
- For deregistration using the Visual Administrator (SAPCCMSR), instead of choosing the *Register* button, choose the *Unregister* button. For deregistration, you only need to enter the password for the *Administration User*.



- Take this opportunity to check that you are using the current version of the agent (currently Patch Collection 2005/6).
- For a better overview in CEN1, check the entries for the agents in the Topology Browser in transaction RZ21 to determine which agents are registered with CEN1.
- During the (de)registration, delete files with the naming convention **GRMG_*** from the GRMG directories on the hosts of your agents. This means that you can continue to work with the scenarios that you have configured in CEN1, without the agents uploading the starting set of scenarios again. By default, the GRMG directory has the path `\\saploc\prfclog\grmg` (Microsoft Windows).

7.4. Availability Monitoring (CCMSPING/GRMG)

7.4.1. Deregister/Register CCMSPING

You need to deregister all CCMSPING agents that are registered with CEN1 and register them with CEN2. There is no system support for this, that is, you need to perform the steps manually in accordance with the usual instructions:

- [Setting Up Availability Monitoring with CCMSPING \[page 23\]](#)

You perform the deregistration in the same way as registration, you simply need to ensure that you replace the parameter **-R** for registration with **-U**.





- Take this opportunity to ensure that you are using the current version of the agent (currently Patch Collection 2005/6).
- You can obtain a list of the CCMSPING agents registered with CEN1 from the *Selfmonitoring CCMS Agents* monitor of the *SAP CCMS Technical Expert Monitors* monitor set, for example.
- If you are installing CCMSPING on a different host, ensure that there is also a **services** file on this host that contains the port numbers of the message servers of the monitorable systems.

7.4.2. Other Settings for Availability Monitoring with CCMSPING

You can transfer other settings for availability monitoring from CEN1 to CEN2 by transporting the corresponding table contents.



To transport all of the contents of a table, start transaction SE16, enter the name of the table, and confirm your entry with **ENTER**. On the selection screen that then appears, choose  (*Execute*), select all entries by choosing  (*Select All*), and choose *Table Entry* → *Transport Entries*.



You can transfer the following availability settings to CEN2 by transporting the corresponding tables from CEN1 to CEN2:

Setting	Table	Special Features/Restrictions
Monitored systems	CSMNSDIC	<p>The table contains a list of the monitorable systems with their monitoring settings.</p>  <p>If CCMSPING has a new RFC destination after the move (this is the case, if the host or instance number of CCMSPING change), you also need to adjust the responsible CCMSPING on the configuration interface for monitored systems (transaction RZ21) after you have transported the table contents.</p>

Setting	Table	Special Features/Restrictions
Monitored application servers	CSMSYSAS	You only need to transport the contents of this table if you have chosen the monitoring setting <i>Only Selected Application Servers</i> or <i>Selected and New Application Servers</i> in the configuration program for CCMSPING in transaction RZ21.
Monitored logon groups	ALAVLPING	You only need to transport the contents of this table if you have chosen the monitoring setting <i>Only Selected Logon Groups</i> or <i>Selected and new Logon Groups</i> in the configuration program for CCMSPING in transaction RZ21.
Monitoring pauses	ALDWNTIME	You only need to transport the contents of this table if you have created monitoring pauses.
CCMSPING groups	ALAVLAGENT	You can only transport the contents of these tables if the RFC destinations of the CCMSPING agents do not change during the move. Otherwise, you need to recreate these settings manually.
Monitoring frequencies	AVAVLCNTRL	

7.4.3. Availability Monitoring with GRMG/GRMGLite

To transfer monitoring settings for GRMG and GRMGLite from CEN1 to CEN2, proceed as follows:

1. Download all GRMG/GRMGLite scenarios from CEN1 to a directory, for example on your front end PC:
 - a) Start transaction GRMG.
 - b) Select all scenarios.
 - c) Choose  *Upload/Download* → *Download Scenario*.
2. Then manually upload these scenarios to CEN2 and start the scenarios:
 - a) Start transaction GRMG.
 - b) Choose the  *Upload* button, and choose one of the scenarios downloaded above.
 - c) Repeat the last step until you have uploaded all scenarios.
 - d) Start the scenarios by selecting all scenarios and choosing the  *Start* button.



- You can always upload only one scenario per step. If you need to upload a large number of scenarios, you can also do this in one step by copying the files to the GRMG directory of any CCMS agent that is registered with CEN2, so that the files are automatically uploaded. Note that you need to assign the prefix **GRMG_** to the files for the scenarios to be automatically uploaded. Scenarios that are automatically uploaded are started at the next system start.

- If scenarios contain encrypted passwords, these are not transferred when you download the scenarios. In this case, you need to reenter the passwords in transaction GRMG in CEN2.

7.5. Settings for Monitored Systems

7.5.1. Entering Monitored ABAP Systems

To transfer the entries for monitored ABAP systems from CEN1 to CEN2, proceed as follows:

1. You need to manually create the RFC connections for data collection and analysis from CEN2 to the monitored ABAP systems (see [Entering Monitored ABAP Systems in CEN \[page 19\]](#)).

To obtain a better overview, you can display the entries for the monitored systems in CEN1 in the Topology Browser. To do this, start transaction RZ21, select the *System Overview* radio button in the *Topology* group box, and choose  *Display Overview*. The corresponding RFC destinations are always shown in the *Read Destination Data* and *Destination Analysis* columns for monitored ABAP systems.

2. You also need to make the monitoring infrastructure in CEN2 aware of the monitored systems manually (see [Entering Monitored ABAP Systems in CEN \[page 19\]](#)).



Only if the RFC destinations to the monitored systems have the same names in CEN1 and CEN2 can you create the list of monitored systems in CEN2 by transporting the corresponding entries in the **ALSYSTEMS** table. To do this, transport the entries that have real RFC destinations in the *DESTINAT* and *DESTINAT_2* columns of the above table (non-ABAP systems have the entry `<<SYSID>_no_ABAP_Destination` in the *DESTINAT* column).

7.5.2. System Groups

To transfer the system groups of the monitoring infrastructure from CEN1 to CEN2, transport the entries of the **ALSYSGRPS** table.



Some system groups are automatically filled. Before transporting the table entries, you should check the system groups for CEN1 entries. To do this, start transaction RZ21, and choose *Technical Infrastructure* → *Configure Central System* → *Maintain System Groups*.

7.5.3. Central Display of Statistics Data with Transaction ST03G

If you want to display statistics data for monitored systems in CEN2, you need to manually create in CEN2 corresponding RFC connections to the monitored systems that exist in CEN1, and make the corresponding entries in transaction ST03G (see [Entering](#)

[Monitored ABAP Systems in ST03G \[page 21\]](#) and [Displaying DSRs for the Java Instance in CEN \[page 30\]](#)).

7.6. Checking the Dataset of the Administrative SLD



You only need to perform this step if you use the NWA in the context of your landscape-wide monitoring.

Check in the administrative SLD that you are using for CEN2 whether there are still associations for CEN1. To do this, proceed as follows:

1. Log on to the administrative SLD and choose *Administration* → *Content Maintenance*.
2. In the *Subset* dropdown list, choose *Associations*, and then choose *Centrally Monitored Application System* in the *Class* dropdown list.
3. Delete any entries that point to CEN1 in the *Dependent* column.

7.7. Central Performance History

The system ID of CEN is contained at various points in the CPH tables (for example, for GRMG and CCMSPING availability values). Manual conversion is therefore very complicated and not practical. This applies both for the dataset of the CPH and for the configuration settings.

If you want to save monitoring data in the CPH in CEN2, perform a corresponding new configuration manually in CEN2. Data collected in CEN1 is lost during the move.





For more information, see the SAP Help Portal under *SAP NetWeaver* → *SAP NetWeaver by Key Capability* → *Solution Life Cycle Management by Key Capability* → *Solution Monitoring* → *Monitoring in the CCMS* → *The Alert Monitor* → *Central Performance History of the Monitoring Architecture* → *Configuring the Central Performance History*, or follow the link below:

http://help.sap.com/saphelp_nw04s/helpdata/en/19/4c773dd1210968e1000000a114084/frameset.htm.

7.8. Properties and Methods

7.8.1. Method Definitions and Releases

To transfer the method definitions and releases from CEN1 to CEN2, proceed as follows:

1. In CEN1, start transaction RZ21, select the *Method Definitions* radio button in the *Methods* group box, and choose  *Display Overview*.
2. Change the current layout so that the *Changed by* field is shown. To do this, choose *Settings* → *Layouts* → *Current...*, select the *Changed by* entry in the *Hidden Fields* group box, and choose  (display selected field). Apply your changes.

3. You should transport all method definitions that you have modified. These are the definitions for which the *Changed by* field does not show *SAP*. Choose a corresponding method by double-clicking it, and choose  (*Transport*).



If you have created your own method definitions that link to your own reports (which in this case are usually in the customer namespace, that is, they begin with **Z**), you also need to transport these reports.

4. You need to perform more advanced configuration steps in CEN2 for some individual method definitions:

In the case of sending a mail if an alert occurs (*CCMS_OnAlert_Email* and related methods) you need to configure SAPconnect (transaction SCOT).



For more information, see the SAP Help Portal under *SAP NetWeaver* → *SAP NetWeaver by Key Capability* → *Application Platform by Key Capability* → *Platform-Wide Services* → *Connectivity* → *Communication Interfaces for Mail and Telephony* → *SAPconnect (BC-SRV-COM)*, or follow the link below:

http://help.sap.com/saphelp_nw04s/helpdata/en/2b/d925bf4b8a11d1894c000e8323c4f/frameset.htm.

In the case of the execution of an operating system command as an auto-reaction method (*CCMS_AUTO_REACT_OP_COMMAND*), you need to define the desired commands in transaction SM69.



For more information, see the SAP Help Portal under *SAP NetWeaver* → *SAP NetWeaver by Key Capability* → *Solution Life Cycle Management by Key Capability* → *System Management* → *Configuration* → *External Operating System Commands: Contents*, or follow the link below:

http://help.sap.com/saphelp_nw04s/helpdata/en/c4/3a6047505211d18955000e829fbbd/frameset.htm.

In the case of the forwarding of an alert to ALM (*CCMS_Send_Alert_to_ALM*), you need to configure alert management.



For more information, see the SAP Help Portal under *SAP NetWeaver* → *SAP NetWeaver by Key Capability* → *Solution Life Cycle Management by Key Capability* → *Solution Monitoring* → *Monitoring in the CCMS* → *The Alert Monitor* → *Select Alert Monitor Methods* → *Forwarding Alerts to Alert Management (ALM)*, or follow the link below:

http://help.sap.com/saphelp_nw04s/helpdata/en/3f/567ddea69d3d4c93a6ae_dabd08899e/frameset.htm.

7.8.2. Properties and Method Assignments

Method assignments and properties of MTE classes and attribute groups are grouped into properties variants. You therefore only need to transport these variants from CEN1 to CEN2. To transfer the properties and method assignments of the monitoring infrastructure from CEN1 to CEN2, proceed as follows:



Most properties and method assignments are stored in the monitored systems. Only the properties and method assignments of nodes for CEN itself and nodes for availability monitoring by CCMSPING und GRMG are stored in CEN.

1. Start transaction RZ21 in CEN1, select the *Properties Variants* radio button in the *Properties* group box, and choose  *Display Overview*.
2. Choose *Variant* → *Transport*, and specify the desired properties variant in the *Variant* input field. Transport all properties variants other than the default properties variant **SAP_DEFAULT***. You do not need to transport these variants, since they are automatically created.
3. Repeat the last step until you have transported all variants.
4. If you have assigned properties methods to different operation modes in CEN1, make this assignment in CEN2. To do this, start transaction RZ04, and choose *Operation Mode* → *Create*.



You cannot transfer the properties from CEN1 to CEN2 as described for the following nodes; you need to manually adjust the properties in CEN2 for these nodes:

- Nodes for which the properties are assigned to the node itself (and not through the MTE class or attribute group). To determine which MTEs have individual properties, start transaction RZ21, select the *MTE-specific properties* radio button in the *Properties* group box, and choose  *Display Overview*.
- Nodes that contain the system ID as part of the name of the MTE class or attribute group. These are nodes for database monitoring (MaxDB) and nodes for PMI self-monitoring (Process Monitoring Infrastructure).

7.8.3. Central Auto-Reactions

If you have configured central auto-reactions in CEN1, transfer these to CEN2 by transporting the contents of the **CSMTOOLASG** table from CEN1 to CEN2.



You can only transport central auto-reactions by transporting the **CSMTOOLASG** table from CEN1 to CEN2, if method definitions corresponding to those in CEN1 also exist in CEN2 with the same names (see [Method Definitions and Releases \[page 84\]](#)).

7.9. Monitor Definitions and Monitor Sets

To transfer the monitor definitions and monitor sets of the monitoring infrastructure from CEN1 to CEN2, proceed as follows:

1. Start transaction RZ20 in CEN1, and choose *Extras* → *Activate Maintenance Function*.
2. Transport all monitor sets that do not have names starting with **SAP**. To do this, select the relevant monitor set, and choose  (*Transport Monitor Set*).
3. Repeat the last step until you have transported all monitor sets.

7.10. Other Points

7.10.1. Monitoring Infrastructure Alerts

The open and completed alerts are lost during a move of CEN.

7.10.2. Special Monitoring Tasks

The following points are only mentioned for the sake of completeness. They relate to configuration steps that you need to perform in a monitored system. They are therefore only relevant if the corresponding monitoring function is active in CEN itself, which is not normally the case:

- **Transaction-Specific Monitoring**

The configuration settings for transaction-specific monitoring (transaction RZ20, monitor *Transaction-Specific Dialog Monitor*) are in the table **ALTRAMONI**.

Transport the contents of this table from CEN1 to CEN2.

- **Monitoring Jobs**

The configuration settings for job monitoring are in the table **ALBTCMON**.

Transport the contents of this table from CEN1 to CEN2.



You can only transfer the monitoring of jobs in this way if the jobs to be monitored in CEN1 and CEN2 have the same names. Otherwise, you need to make a new configuration in CEN2.

You also need to define the method `CCMS_BATCH_MONITORING` as a startup method. However, if you have transported all changed method definitions to CEN2 (see [Method Definitions and Releases \[page 84\]](#)), this is already the case in CEN2.

- **qRFC Monitoring**

You can transport the configuration settings for qRFC monitoring using the view cluster maintenance. To do this, start transaction SM34, and enter `QRFC_MONITORING_E` in the *View cluster* input field. Choose  (*Transport*). After the prompt for the request, you can include the *Setting Owner* in the request (include dependent entries in the request, too).



For more information, see the SAP Help Portal under *SAP NetWeaver* → *SAP NetWeaver by Key Capability* → *Solution Life Cycle Management by Key Capability* → *Solution Monitoring* → *Monitoring in the CCMS* → *The Alert Monitor* → *Special Monitoring Functions of the Alert Monitor* → *Monitoring qRFC and tRFC Calls* → *Set Up Monitoring of qRFC Calls*, or follow the link below:

http://help.sap.com/saphelp_nw04s/helpdata/en/52/12f73b7803b009e1000000a114084/frameset.htm

8. Additional Information

8.1. Known Problems

8.1.1. Error when Generating the CSMCONF Start File

If you want to create the CSMCONF start file for the registration of a CCMS agent (see [Creating the CSMCONF Start File for CCMS Agents \[page 19\]](#)), an error with the message `Error when calling data provider` can occur. This is the case if you are using SAP GUI for Windows 6.40 with a Patch Level of up to 4.

Solution:

Use at least SAP GUI for Windows 6.40 Patch Level 5. For information about downloading and installing patches, see SAP Notes 563161, 330793, and 535308.

8.1.2. Agent registration not possible with Visual Administrator

The agent registration on Windows platforms in the Visual Administrator terminates with the following message:

```
OpenSCManager failed...      ERROR: service registration failed
```

Solution:

Register the CCMS SAPCCMSR agent manually in accordance with SAP note 817714.

8.1.3. Tab Page *CCMS Agent Configuration* in VA is missing

The automatic agent registration in the Visual Administrator is not possible, because the tab page *CCMS Agent Configuration* in the service *Monitoring* of the dispatcher is not displayed. This problem can occur in SAP NetWeaver 7.0 up to SP Stack 07.

Solution:

Follow the correction instructions as described in SAP note 929635.

8.1.4. Agent registration fails due to wrong password

Registrations of CCMS agents at the central monitoring system fail, if you specify a CSMREG password that contains lowercase letters. You will see agent registration errors such as the following:

```
ERROR: RFC error during logon: 104 Name or password is not
correct. Repeat the registration.
```

```
WARNING: RFC client functionality configured, but logon failed
for [P05:000:CSMREG] ==> pushing data into CCMS cache disabled.
```

Solution:

Follow the correction instructions as described in SAP note 884715 or specify a password for CSMREG that contains only upper case

8.2. SAP Service Marketplace

[Agents] Documentation for the CCMS Agents

Start the SAP Service Marketplace, and go to the *System Monitoring and Alert Management* area (<http://service.sap.com/monitoring>). Choose *Monitoring in Detail*, and choose the document *CCMS Agents: Features, Installation, and Usage* from the list ([direct link](#)).

There is also a SAP Tutor that describes working with CCMS agents using examples. Start the SAP Service Marketplace, and go to the *System Monitoring and Alert Management* area (<http://service.sap.com/monitoring>). Choose *Education & Workshops*, and then choose the document *Installation, Registration, and Customizing of CCMS Agents* from the list ([direct link](#)).

[SAPOSCOL] SAPOSCOL: Properties, Installation, and Operation

Start the SAP Service Marketplace, and go to the *System Monitoring and Alert Management* area (<http://service.sap.com/monitoring>). Choose *Monitoring in Detail*, and then choose the document *SAPOSCOL: Properties, Installation, and Operation* from the list ([direct link](#)).

[CCMSPING] Availability Monitoring and CCMSPING

Start the SAP Service Marketplace, and go to the *System Monitoring and Alert Management* area (<http://service.sap.com/monitoring>). Choose *Monitoring in Detail*, and then choose the document *Availability Monitoring and CCMSPING* from the list ([direct link](#)).

[GRMG] Instrumenting Components for Monitoring with the GRMG

Start the SAP Service Marketplace, and go to the *System Monitoring and Alert Management* area (<http://service.sap.com/monitoring>). Choose *Developers' Zone*, and choose the document *Instrumenting Components for Monitoring with the GRMG* from the list ([direct link](#)).

8.3. Useful SAP Notes

[734247](#)

CCMS Agents: Java Interfaces for Registration

During the registration of the agent, you must enter a large quantity of data about CEN, the connection to it, and possibly the monitored J2EE instance. This Java tool is provided to simplify the registration.

[634771](#)

GRMG Customizing File for XI CCMS Heartbeat Monitoring

The *Configuration Guide* for the Exchange Infrastructure describes how you can include Java components in the CCMS monitoring. To activate “heartbeat monitoring” for the individual Java components, you require a GRMG Customizing file. This SAP Note contains a template for this file as an attachment. It also contains instructions about how you need to adjust the file.

[897226](#)

TREX 7.0: Monitoring TREX with CCMS

Attached to this note you will find the document *Monitoring TREX with CCMS*. This document describes both how to configure the TREX

monitoring in CCMS and how to monitor TREX with the help of CCMS.

[706290](#)

GRMG Configuration for BI UD Connect

This SAP Note describes the configuration of the availability monitoring of DU Connect with the GRMG. The configuration involves adjusting the template of the GRMG Customizing file and loading it into the central monitoring system.

[535199](#)

CCMS Agents: Monitoring Log Files

In the context of monitoring systems and system landscapes, it is possible to use CCMS agents to monitor log files; that is, to search specific files for one or more word patterns. If a search pattern is found, the monitoring architecture generates a message or an alert from it. This SAP Note describes the configuration required for this.